

# Model FV 130.2

Door-type high temperature sanitizing pot washer

## Installation, Operation and Maintenance manual



For the types of the series:  
M006DWFL10M1-20



**Before using the machine, carefully read the operating instructions, product description and safety instructions!**

# Contents

<b>1</b>	<b>NOTES ON THE OPERATING INSTRUCTIONS .....</b>	<b>5</b>
1.1	Product identification	5
1.2	Delivery contents	5
1.3	Related documents	5
1.4	Illustration	6
1.4.1	<i>Warnings</i>	6
1.4.2	<i>Notices on use</i>	6
1.4.3	<i>Safety symbols in the instructions</i>	7
<b>2</b>	<b>GUARANTEE .....</b>	<b>7</b>
<b>3</b>	<b>SAFETY .....</b>	<b>7</b>
3.1	Intended use	7
3.2	Misuse	7
3.3	Safety information	8
3.4	What to do in the event of an emergency	9
3.5	Safety notices on the machine	10
3.6	Requirements for the personnel	10
3.7	Electromagnetic compatibility	12
<b>4</b>	<b>PRODUCT DESCRIPTION .....</b>	<b>12</b>
4.1	Functional description	12
4.2	Overview illustration	13
4.3	Membrane keypad	14
4.4	Wash programs	16
4.5	Detergent and rinse aid	17
4.5.1	<i>Detergent</i>	17
4.5.2	<i>Rinse aid</i>	17
4.5.3	<i>Checking the correct dosing settings</i>	18
4.5.4	<i>Dosing units</i>	18
4.5.5	<i>Change of products</i>	18
4.6	Options	19
4.6.1	<i>Power Vent fan</i>	19
4.6.2	<i>Waste air heat recovery (AirConcept)</i>	19
4.7	Additional equipment	19
<b>5</b>	<b>TECHNICAL DATA .....</b>	<b>20</b>

<b>6</b>	<b>TRANSPORT.....</b>	<b>20</b>
6.1	Disposal of packaging materials	22
<b>7</b>	<b>REQUIREMENTS FOR INSTALLATION .....</b>	<b>22</b>
7.1	Requirements for the installation location	22
7.2	Requirements for the wastewater connection	22
7.3	Requirements for the fresh water connection	23
7.4	Requirements for the electrical connection	24
<b>8</b>	<b>INSTALLATION.....</b>	<b>25</b>
8.1	Install waste air heat recovery (WAHR option)	25
8.2	Installing the Power Vent (optional)	30
8.3	Accessing the utility connections	37
8.4	Electrical installation	37
8.5	Connecting the fresh water pipe	40
8.6	Connecting the wastewater pipe	41
8.7	Connection for wastewater temperature control (optional)	42
8.8	Connecting the dosing system	43
8.9	Connecting the detergent and rinse aid canisters	44
8.10	Terminating the installation	45
<b>9</b>	<b>COMMISSIONING .....</b>	<b>45</b>
9.1	Checking the requirements for commissioning	45
9.2	Performing commissioning	46
9.3	Venting (priming) the pipes	46
<b>10</b>	<b>OPERATION/USE .....</b>	<b>47</b>
10.1	Prior to switching on the machine	47
10.1.1	<i>Starting up the dishwasher</i>	49
10.2	Washing	50
10.2.1	<i>Useful information for loading the washware</i>	50
10.2.2	<i>Selecting the wash program</i>	52
10.2.3	<i>Starting the wash cycle</i>	53
10.2.4	<i>Unloading the washware</i>	54
10.3	Switching off the machine	56
10.4	Replacing the canisters	57
10.5	Malfunctions	58

10.5.1	<i>Messages</i>	59
10.6	Modifying the settings	64
10.7	Level 1 - User settings (Code 10001)	64
10.7.1	<i>Viewing the parameters</i>	65
10.7.2	<i>Venting (priming) the pipes</i>	65
10.8	Level 2 - Dosing system settings (Code 40044)	66
<b>11</b>	<b>CLEANING THE MACHINE .....</b>	<b>67</b>
11.1	Daily cleaning	68
11.2	Weekly cleaning	69
11.3	Cleaning the membrane keypad	70
11.4	Cleaning outer stainless steel surfaces	70
11.5	Cleaning the surrounding area	71
11.6	Descaling	71
<b>12</b>	<b>MAINTENANCE .....</b>	<b>72</b>
12.1	Maintenance work	73
12.2	Maintenance plan	74
<b>13</b>	<b>DISMANTLING AND DISPOSAL .....</b>	<b>76</b>
13.1	Dismantling and disposal of the old machine	76
<b>14</b>	<b>INDEX .....</b>	<b>77</b>
<b>15</b>	<b>NOTES .....</b>	<b>79</b>

# 1 Notes on the operating instructions

The operating instructions as well as the applicable documents must be read before initial commissioning, kept for later use, and be accessible to the operator at all times. Failure to observe the operating instructions may result in damage to persons and property.

These operating instructions can be downloaded at the following address:  
**www.meiko.com** or <https://partnet.meiko-global.com>.

## 1.1 Product identification

These operating instructions apply to the following machine types:

- Pot washer FV 130.2

FV 130.2 :            M006DWFL10M1-20

## 1.2 Delivery contents

- FV 130.2 pot and pan washer
- Rack
- Connection hoses for fresh water and wastewater
- Documentation

## 1.3 Related documents

In addition to these operating instructions, there are other documents:

- Short operating instructions
- Wiring diagram (behind the lower front panel)
- Data sheet with technical data and dimensions

## 1.4 Illustration

### 1.4.1 Warnings



**WARNING** – indicates a potentially hazardous situation which, if not avoided, could result in serious injury or death.



**CAUTION** – indicates a possible hazardous situation which, if not avoided, could result in minor or moderate injury or damage to property.

### 1.4.2 Notices on use

**NOTE** – indicates a possible hazardous situation which could result in damage to property.







**IMPORTANT** – indicates useful information about the product or its use.

#### Notes on using the document:

- A bullet point (•) indicates a list.
- Numerals (1.) indicate several action steps that must be executed in the specified order.
- Position numbers in the text that refer to position numbers in figures are shown in parentheses:  
(1) Position number 1 in the figure
- The text is always below the figure and refers to it until a new image follows.

### 1.4.3 Safety symbols in the instructions

	Read the operating instructions		Disconnect from the power supply
	Potential equalization connection		Warning of dangerous electric voltage
	Manufacturer		

## 2 Guarantee

FOR WARRANTY ACTIVATION,

please contact your authorized MEIKO service partner.

For an ASA listing, please refer to either the QR code on the back cover of this manual or visit our website at [www.meiko.us](http://www.meiko.us). You may also contact MEIKO service directly at (800) 868-3840.

You will be asked to schedule your performance and installation inspection. This inspection is provided FREE OF CHARGE to ensure that your new machine is properly installed.

**YOUR GUARANTEE IS NOT VALID UNTIL THIS FREE INSPECTION HAS BEEN COMPLETED BY YOUR AUTHORIZED SERVICE AGENCY.**

## 3 Safety

Read and observe all safety information, instructions and symbols attached to the product. Improper use may result in damage to the product or danger to the user.

### 3.1 Intended use

The dishwasher is intended for commercial use only and is designed to wash dishes, cutlery, glasses, kitchen utensils, baking sheets, and containers. The washware must be suitable for commercial dishwashers.

### 3.2 Misuse

- Washing electrical appliances.
- Washing textiles.
- Washing living creatures.

- Washing/preparing food.
- Washing items that must not come into contact with foodstuffs (e.g., ashtrays, candlesticks).
- Washing ferrous, non-corrosion-resistant objects (steel sponges, gratings, etc.)
- Washing objects that have come into contact with hazardous substances (health hazards, in particular toxic, highly, or extremely flammable, and explosive substances).
- Washing aluminium parts only with a suitable detergent.
- Washing objects made of wood.
- Washing plastic parts that are not heat- and alkali-stable
- Using hand dishwashing detergent for pre-cleaning.
- Filling the machine from an external source (e.g. with a hand spray).
- Disposing of dirty water via the machine (e.g. from a cleaning bucket).
- Standing or sitting on machine parts or using the machine as a climbing aid.

### **3.3 Safety information**

- Do not open the door while the program is running.
- Only operate the dishwasher when it is in perfect working order. All protection devices and housing parts as well as the tank cover sieve must be installed.
- Place washware, in particular small items, in the appropriate rack inserts.
- The washware must not come into contact with the wash arms/rinse arms of the dishwasher.
- Wear suitable work clothing, protective gloves and sturdy shoes.
- Do not wear rings, necklaces or other pieces of jewelry.
- Connect the suction lances of the dishwasher correctly to the canisters.
- Use optional bought-in parts in accordance with the associated instructions.

#### **Electrical connection, see page 24.**

- The power supply must be fused in accordance with the regulations and a lockable main switch provided in the local electrical installation.
- The electrical safety of this machine is only ensured if it is connected to a properly installed protective conductor system. It is very important to verify this fundamental safety feature. If in doubt, have the building wiring checked by an electrically skilled person.

- Carry out the protective measures as well as the equipotential bonding connection in accordance with the regulations of the local power supply companies as well as the locally applicable regulations.

### **Fresh water connection**

- Installation components must be suitable and permitted in accordance with local regulations.
- Turn off the shut-off valve of the fresh water supply line before carrying out installation work. Check that all lines are securely connected and tight.
- When replacing an old machine with a new one, make sure that the existing feed hose is exchanged for the new feed hose supplied with the machine.

### **Environment**

- Do not remove safety and warning notices from the dishwasher and ensure they are legible. Replace any damaged safety and warning notices.
- Do not process hazardous substances (hazardous to health, especially toxic, highly flammable and explosive substances) in the machine.
- Do not operate the dishwasher in a potentially explosive atmosphere.

### **Maintenance and repair**

- Observe the maintenance specifications and intervals, including those of optional bought-in parts.
- Only use original spare parts from the manufacturer.
- Before opening the housing parts, ensure the local main switch has been disconnected from power and secured so that it cannot be switched on again.

### **Conversions**

- Installation of an external dosing system is possible. Other modifications to the machine are not permissible.
- The safety of the dishwasher must not be impaired by the subsequent installation of a dosing system. Only use dosing technology approved by MEIKO.

## **3.4 What to do in the event of an emergency**



- In dangerous situations, disconnect the machine from the power supply using the available main switch.

### 3.5 Safety notices on the machine

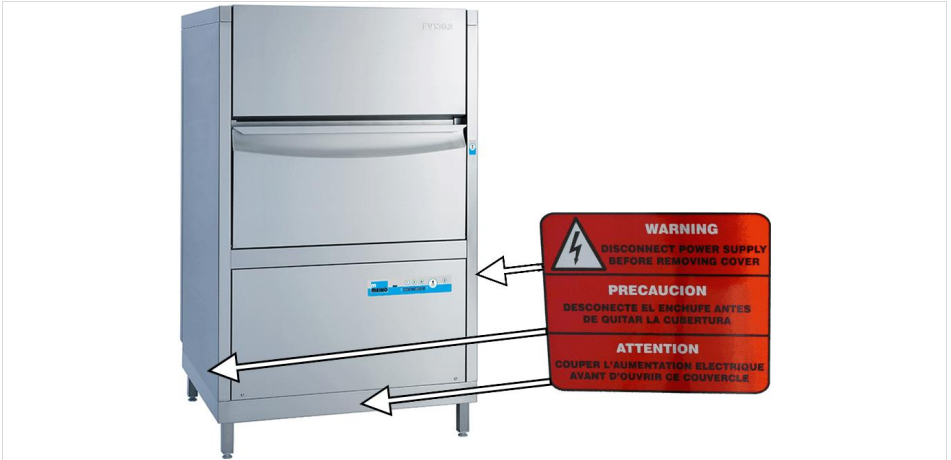

The safety notice is located on the right side panel and on the rear panel.

### 3.6 Requirements for the personnel

Installation, commissioning, instruction, repairs and maintenance of MEIKO products may only be carried out by authorized service partners.

The operator must check the area around the machine or system for hazards to other persons, e.g. children or persons with reduced physical, sensory or mental capabilities, or with a lack of experience or knowledge.

During operation it must be ensured that:

- Only adequately trained and instructed personnel are allowed to work on the machine.
- Personnel responsibilities for operation, maintenance and repairs must be clearly defined.
- Any personnel undergoing training are only allowed to work on the machine under the supervision of an experienced person.
- No person is under the influence of alcohol, drugs or medication (perceptual disorder).

The required qualifications for performing specific work on the machine are determined by MEIKO:

Activity	Persons		
	Trained operating personnel	In-house technician authorized by MEIKO	Service technician authorized by MEIKO
Operation, use	✓	✓	✓
Cleaning	✓	✓	✓
Checking safety devices		✓	✓
Troubleshooting	✓	✓	✓
Troubleshooting, mechanical	✓	✓	✓
Troubleshooting, electrical		✓*	✓
Maintenance		✓	✓
Repairs		✓	✓

\* When trained as an electrically skilled person



**Note**

The instructions must be acknowledged in writing.

**Qualified personnel**, as defined by these operating instructions, are persons who:

- Are over 14 years of age.
- Due to their training, experience and instruction are able to perform the required activities.
- Are authorized to perform the required activities by the person responsible for safety of the machine.
- Have read and understood the operating instructions and corresponding safety information and will follow them.

## 3.7 Electromagnetic compatibility



### NOTE:

This equipment has been tested and found to comply with the limits for a Class A digital device, pursuant to part 15 of the FCC Rules. These limits are designed to provide reasonable protection against harmful interference when the equipment is operated in a commercial environment.

This equipment generates, uses, and can radiate radio frequency energy and, if not installed and used in accordance with the instruction manual, may cause harmful interference to radio communications. Operation of this equipment in a residential area is likely to cause harmful interference in which case the user will be required to correct the interference at his own expense.

## 4 Product description

### 4.1 Functional description

The dishwasher has one wash cycle and one final rinse cycle.

A temperature controller keeps the set wash temperature at 155°F (66°C), minimum. A rotary pump circulates the water from the wash tank into the wash nozzles. The water jets hit the washware from different directions. This ensures uniform washing results.

The wash cycle is followed by a fresh water final rinse. A separate nozzle system rinses the washware using hot fresh water with at least 180°F (82°C). This heats up the washware for the subsequent drying process.

At the same time, the rinse water is used to regenerate the wash water; this reduces the degree of soiling of the wash water.

## 4.2 Overview illustration

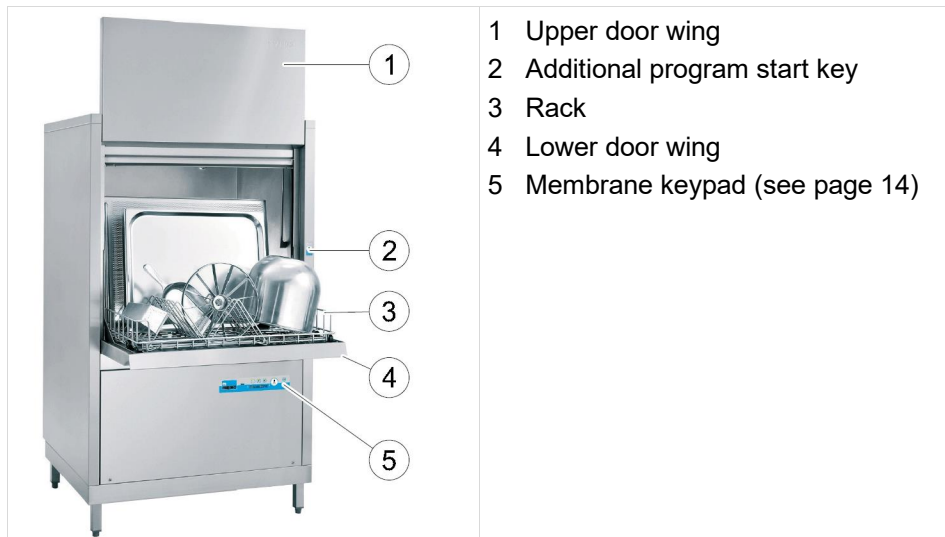

### 4.3 Membrane keypad

The membrane keypad has 5 keys and 4 control lights. The display reports the current temperatures of the wash and rinse water and displays information messages and error codes where applicable. The control lights at the keys indicate readiness for operation, the active wash program, and a running wash cycle.

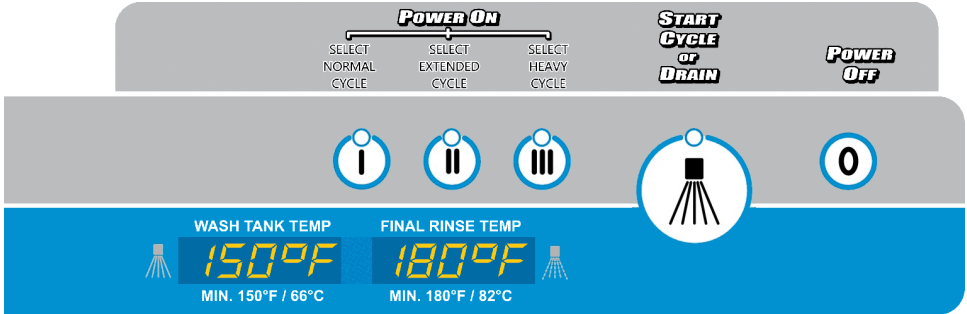

Key
<p><b>START key with control light</b></p> <ul style="list-style-type: none"><li>• Starts the program</li><li>• Control light on: wash program is running</li><li>• Control light flashing: self-cleaning program/drain program is running</li></ul>
<p><b>STOP key</b></p> <ul style="list-style-type: none"><li>• Program stops</li><li>• Switch-off/prepares self-cleaning feature</li></ul>
<p><b>Program keys 1–3 with control lights</b></p> <ul style="list-style-type: none"><li>• Any key switches the dishwasher on</li><li>• Program selection</li></ul>

## Key

- Control light 1, 2 or 3 on: dishwasher ready for operation/wash program 1, 2, or 3 selected
- Control light 1, 2 or 3 flashing: dishwasher is being made ready for operation

## Display

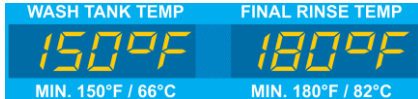

Display	Meaning
	Current wash temperature   current final rinse temperature

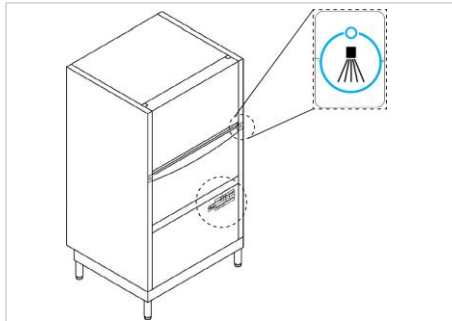
## Additional program start key for ergonomic operation



## 4.4 Wash programs

### FV 130.2

Program	Meaning	Washware
	Short – 3 minutes	Lightly soiled washware
	Standard – 5 minutes	Normally soiled washware
	Intensive – 8 minutes	Heavily soiled washware pots, containers, kitchen utensils

### Program assignment

No.	Setpoint for boiler temperature		Setpoint for wash cycle time	
			Washing	Total
	[°F]	[°C]	[s]	[s]
1	185	85	155	180
2	185	85	275	300
3	185	85	455	480

### NOTE

The concentration of the rinse aid in the water remains constant: if the rinse time is changed, the dosing amount of the rinse aid changes correspondingly.

## 4.5 Detergent and rinse aid



### **WARNING – Risk of injury from contact with chemicals**

- Observe the safety data sheets and dosing recommendations of the chemical manufacturers.
- Use safety eyewear.
- Wear protective gloves.
- Do not mix different chemical products.



### **CAUTION**

- Only use products that are suitable and approved for commercial dishwashers.
- Do not mix different detergents.

By default, the dishwasher is provided with dosing units for dosing liquid detergent/rinse aid. Manual dosing with powder cleaner is not intended.

### **4.5.1 Detergent**

Detergents are alkaline (pH value should be  $>7$ ) and are needed to dissolve soiling from the washware. If necessary, the concentration can be adjusted depending on the water quality, washware and degree of soiling. This setting is made during commissioning by an authorized MEIKO service technician or the chemicals supplier. The typical concentration is 0.256 oz/gallon (2 ml/l).

### **4.5.2 Rinse aid**

Rinse aids are acidic (pH value should be between 2 and 7) and accelerate drying of the washware by reducing the surface tension of the water so that it can run off the washware quickly.

Dosing depends on the local water quality and is correct when the water drips evenly from the washware. This setting is made during commissioning by an authorized MEIKO service technician or the chemicals supplier. The typical concentration is 0.0256 oz/gallon (0.2 ml/l).

### 4.5.3 Checking the correct dosing settings

To check if the normal settings are correct for your chemicals, run three empty wash cycles without a rack to completely cycle the water system and obtain accurate test results. This will only take a few minutes. Then, run a sample load with soiled dishes and examine the results.

- If the detergent setting is too low, the dishes will not be adequately cleaned. In some cases, this can be corrected by simply selecting a longer program time (using the cycle selection II (Extended) or cycle selection III (Heavy) keys). However, the detergent concentration may also need to be adjusted.
- Low rinse aid settings may cause spotting and streaking on the dishes.
- If too much of one of the two chemicals is added, the additional chemicals will be wasted. Often, this is difficult to recognize unless you determine the period your chemicals supply will last. In case the chemicals are used up quickly, you might need to adjust the concentration of the chemicals.

**Any adjustments to the factory-set chemical dosing system may ONLY be performed by an authorized MEIKO service partner. Changes by non-authorized personnel will void the guarantee.**

### 4.5.4 Dosing units

The components of the dosing units are subject to high demands and must therefore be regularly maintained and, if necessary, replaced in accordance with the maintenance specification.

The service life of the dosing units and other dishwasher components depends on the use of suitable chemicals.

### 4.5.5 Change of products



#### **CAUTION**

**When changing the detergent product (even to a product from the same manufacturer), crystallization may occur, which can lead to failure of the dosing system.**

- When changing the detergent product, flush the dosing system using warm water.

#### **Procedure for changing the detergent product:**

1. Provide a suitable container with warm water and insert the suction lance.

2. Thoroughly flush the dosing system several times by **venting (priming) the lines**, see page 46.
3. Wipe the suction lance and put it into the canister with the other detergent product.
4. Refill the dosing system by **venting (priming) the lines**.

## **4.6 Options**

### **4.6.1 Power Vent fan**

The Power Vent fan is located on top of the machine; at the end of the program cycle, it draws the hot steam out of the machine and into an on site ventilation system.

### **4.6.2 Waste air heat recovery (AirConcept)**

The waste air heat recovery system is a heat exchanger on top of the machine through which the cold fresh water is passed. The fresh water is heated in the process and the waste heat and humidity of the machine have less of a negative impact on the room air.

## **4.7 Additional equipment**

### **Auto Safe**

An internal boiler heating is regulated by the electronic control system to ensure a proper final rinse temperature, regardless of the fresh water temperature.

### **Soft Start**

The wash water is pumped at a reduced pressure for the first few seconds of the wash cycle. This protects the washware from being damaged by a sudden burst of pressure.

### **Pressure booster pump**

A pressure booster pump ensures that the final rinse pressure remains constant.

### **Drain pump**

For wall drains or floor drains.

### **Aqua Stop**

Automatically shuts the machine down if a water leak is detected.

## 5 Technical data

MEIKO has created a data sheet that shows machine dimensions as well as connection and consumption values.

For additional data, please refer to the data sheet.

### Net weight (without packaging)

Version	Weight, approx.
FV 130.2	595 lbs (270 kg)

### Noise emission

Workplace noise level  $L_{pA} \leq 70$  dB(A).

## 6 Transport



### IMPORTANT

During shipping and installation, the machine must be positioned upright or on its left side. Some water may remain in the lines after pre-shipment testing. If the unit is positioned in any manner **except** upright or on its left side, this water can affect the operation of the water level sensor.

- Check that the delivery is complete immediately upon receipt by comparing it with MEIKO's order confirmation and/or the delivery note.
- If applicable, submit claims for any missing parts immediately to the freight forwarder and notify MEIKO.
- Check the machine for shipping damage.

## NOTE

If you suspect any shipping damage, the shipping company and MEIKO (Customer Service (800) 868-3840) must be informed immediately in writing. Photograph any damaged parts and send the pictures to MEIKO.



### **WARNING – Danger of injury due to machine tipping**

- Only qualified personnel may carry out transport works.
- Please observe the safety information on the packaging.
- Always transport the machine on a wooden frame only.
- Wear protective gloves and safety shoes.

The packaging is specifically designed to allow the machine to be moved safely and securely using a pallet jack. For safe transport, the product is supported by a special square timber frame.

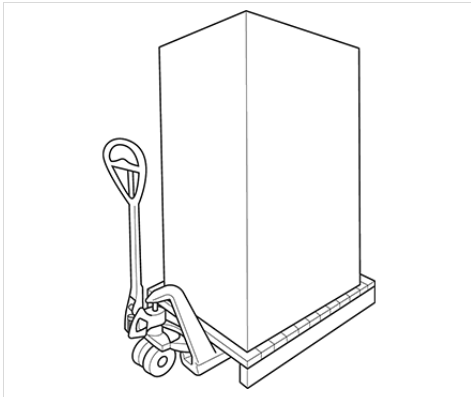

- Execute transport carefully.
- Observe the instructions for safe transport on the packaging.
- Open packaging using a suitable tool.
- Do not unpack the product until it has been transported.

## 6.1 Disposal of packaging materials

All the packaging is made from recyclable materials. The following materials are used:

- Square timber frame
- Plastic sheeting (PE film)
- Foam material
- Cardboard packaging (edge protection)
- Packaging strap (steel strip)
- Packaging strap (plastic (PP))
- If needed, Transport safety bracket (stainless steel)

## 7 Requirements for installation

### 7.1 Requirements for the installation location

- The area **MUST** be frost-free. Freezing temperatures (32°F/0°C or lower) inhibit proper operation and can damage internal components.
- The area **MUST** have a firm floor surface. It is possible to compensate for uneven flooring by adjusting the feet.
- The area should be away from appliances, furniture or surfaces that can be damaged by steam. If this is not possible, these items should be protected from the small quantities of steam that are released during normal operation of the machine.

### 7.2 Requirements for the wastewater connection

A wastewater pipe is integrated into the drain pump.

- Connect the drain hose to the on-site wastewater pipe.
- Observe the minimum height for the drain of 24" (610 mm).
- Minimum diameter of the drain: 1 ½" (38 mm).
- Depending on the dishwasher's field of application, a grease trap may be included, based on the general/location-specific regulations.
- Drain Water temperature can be in excess of 150 °F (65 °C). If a local plumbing code requires a lower drain temperature, please refer to optional Drain Water Tempering kit.

## 7.3 Requirements for the fresh water connection

**Fresh water connections and their components must be made in accordance with local regulations. From a biological perspective, the fresh water must be of drinking water quality. This also applies to treated water.**

Installation components and materials must be suitable and permitted in accordance with local regulations. A solenoid valve is integrated into the dishwasher's fresh water pipe. This, together with the leakage detector in the base drip tray in the subframe, ensures that the fresh water supply is shut off in the event of a leak in the machine.

### **Recommended water hardness:**

- 1–3 grains per U.S. gallon (gpg) (6 gpg, maximum)

### **Recommended water temperature:**

- 140°F (60°C)

Colder water will result in a longer preheat time during startup and will extend the wash cycle time. The required temperatures will still be reached.

### **Pressure range of the fresh water supply flow pressure upstream of the solenoid valve:**

- 8.7–72.5 psi (0.6–5 bar)

### **Measures to ensure correct water pressure:**

- If the minimum flow pressure is too low, increase the pressure using a pressure booster pump (not supplied as standard).
- If the maximum pressure is exceeded, limit the pressure using a pressure regulator (not supplied as standard).

### **Other measures:**

- Make sure that no foreign iron particles can enter the machine via the fresh water connection. The same also applies to contamination by other metal particles (e.g. copper shavings).
- A dirt trap must be fitted in the fresh water supply to protect the solenoid valve. An additional dirt trap is not required.
- The feed hose must be sufficiently long so that the machine can be moved for servicing purposes.

## 7.4 Requirements for the electrical connection



### **IMPORTANT**

The wiring diagram is under the upper cover of the dishwasher. It must remain in the dishwasher. The rating plate with the electrical connected values is on the inside of the front panel and on the outside on the right side panel.

### **Requirements for the operating company:**

- The correct voltage and current type must be available.
- Safeguard the power supply in accordance with the regulations and provide it with an all-pole main switch in the permanently installed electrical installation.
- Connect the dishwasher to an equipotential bonding system.
- Do not connect any additional consumers to the fuse protecting the dishwasher.
- Electricity supply without a neutral conductor (N): When connecting to three-phase current, use a 4-pole terminal strip (L1, L2, L3, PE) or a 3-pole terminal strip (L1, L2, PE).

The products are intended for permanent connection to the locally available power supply and have been tested for the market accordingly. Any other type of electrical connection must be made by specially trained personnel.

Install the dishwasher in accordance with local regulations. In the absence of any such regulations, install the machine in accordance with the applicable requirements in the National Electrical Code, NFPA 70, Canadian Electrical Code (CEC), Part 1, CSA C22.1 and the Standard for Ventilation Control and Fire Protection of Commercial Cooking Operations, NFPA 96.

## 8 Installation

### ▶ IMPORTANT

During shipping and installation, the machine must be positioned upright or on its left side. Some water may remain in the lines after pre-shipment testing. If the unit is positioned in any manner **except** upright or on its left side, this water can affect the operation of the water level sensor.

### ▶ IMPORTANT

Installation may be performed only by an authorized service technician.

### 8.1 Install waste air heat recovery (WAHR option)

#### Tool:

- PH1 Phillips screwdriver
- Flexible extension with socket
- Open-end wrench, 8 mm
- Spring band clamp pliers

#### Material:

- Waste air heat recovery system mounting kit (MEIKO 9795016)

#### Installing the heat exchanger on the machine and connecting the hoses

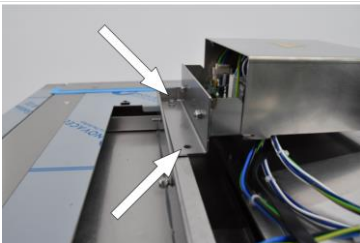

1. Remove the electrical box of the waste air heat recovery system together with the holder on the top of the machine.



2. Place the heat exchanger on the machine. Connections point to the right when viewed from the rear of the machine.



3. Insert the drip tray on the side of the connections.

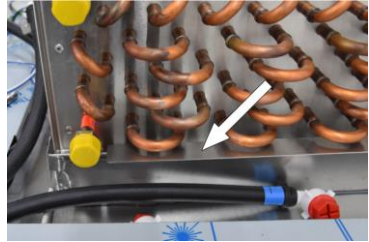

4. Secure the heat exchanger to the threaded bolts using four M5 self-locking nuts.

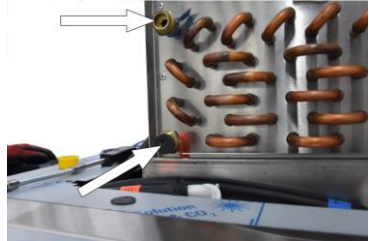

5. Unscrew the protective caps from the connections and remove the rubber cover.



6. Remove the transport locks from the hoses.



7. For the hoses for cold and hot water, check whether the seal is present in the connection piece.



8. Carefully connect the hoses for cold and hot water to the heat exchanger in accordance with the marking. Make sure that the hoses are not laid kinked.



9. Push the hose over the elbow connector, use spring band clamp pliers to push the spring band clamp upwards and secure the hose.  
The heat exchanger is installed and the hoses are connected.

### Connecting the electrics of the waste air heat recovery system

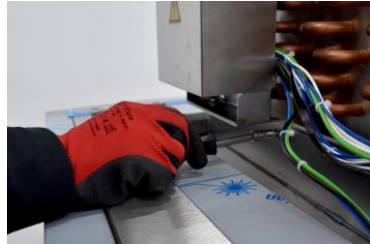

1. Place the electrical box of the waste air heat recovery system on the left-hand side as viewing from the rear of the machine and secure it to the machine using the holder with two M5 self-locking nuts.



2. Place the fan module on the heat exchanger and secure it to the heat exchanger using four M5 self-locking nuts.

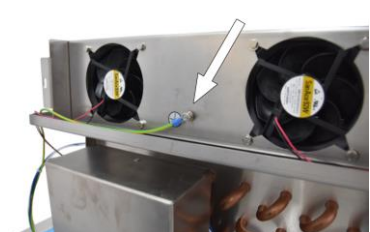

3. Guide the cable for equipotential bonding from the electrical box to the fan module and connect it to the earthing screw.



4. Connect the four plugs of the fan cables to the plugs of the electrical box.



5. Secure the angle plate with solenoid valve to the center threaded bolt using two M5 nuts.



6. Loop the cables around each of the four plugs and secure them to the plug using a cable tie.

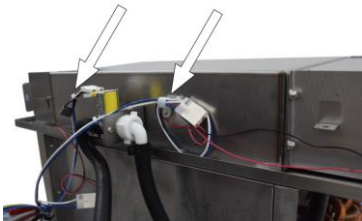

7. Attach cable clamps to the left and right threaded bolts on both sides of the fan module using an M5 nut and secure the cables.

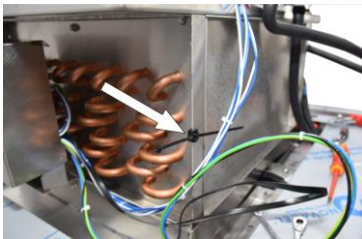

8. Attach the cable tie holder to the heat exchanger and secure the cables. The waste air heat recovery system is electrically connected.

## Fitting the covers

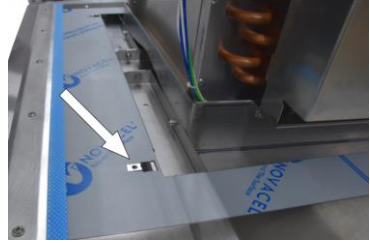
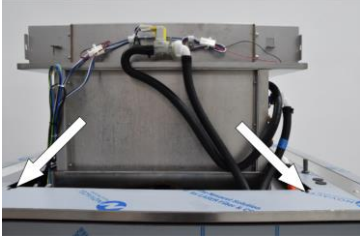

1. Fit four snap nuts in the recesses on the top of the machine.



2. Place the side cover of the heat exchanger on the machine and secure it using four Phillips-head screws.

3. Fit a snap nut to the slotted hole on each of the four sides of the fan module.

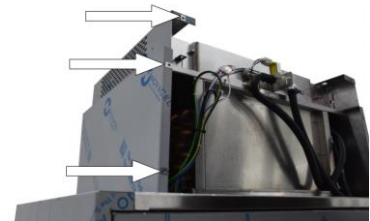
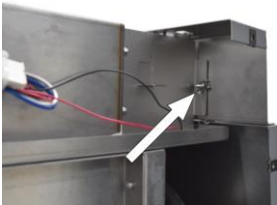

4. Place the side cover of the fan module on the heat exchanger and secure it to the sides using four Phillips-head screws.

5. Fit three snap nuts in the recesses on each side of the side covers of the heat exchanger and fan module.



6. Fit the cover for the rear of the exhaust air heat exchanger and secure it on each side using three Phillips-head screws and on the machine using 2 Phillips-head screws.

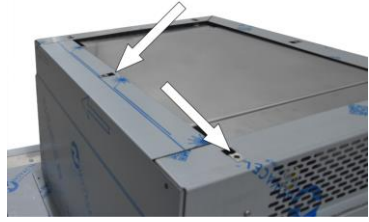

7. Fit six snap nuts to the top of the side cover of the fan module.



8. Fit the top cover and secure it using six Phillips-head screws. The waste air heat recovery system is installed on the machine.

## 8.2 Installing the Power Vent (optional)

### IMPORTANT

Before you start, disconnect the appliance from the power supply and have all tools and parts ready.

Follow these step-by-step instructions to install the Power Vent fan.

### Tools

- Phillips screwdriver
- 13 mm socket wrench insert
- Pipe wrench
- Flat-head screwdriver
- Flexible socket wrench extension piece
- Cordless screwdriver

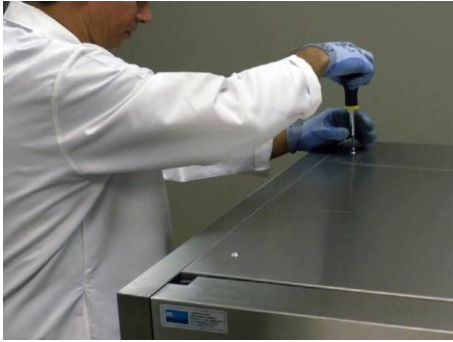

1. Remove the cover on the top of the appliance using a Phillips screwdriver.



2. Lift the cover and slide the side with the break-out opening slightly over the edge.

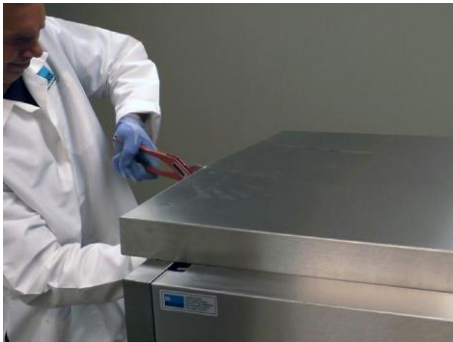

3. Use two pipe wrenches to break off the tabs on both sides.



4. Bend the plate back and forth to break off the two tabs at the top.



5. Remove the top cover and set it aside.



6. Remove the temporary plate using a 13 mm socket wrench.

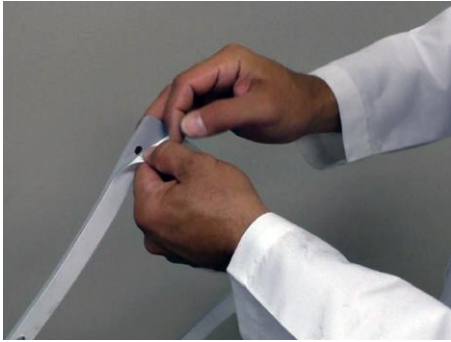

7. Remove the film from the back of the seal.



8. Place the seal over the screw pins with the adhesive side facing down and press firmly all around.



9. Lift the electric fan and align the screw eyelets with the holes on the underside.



10. Use a 13 mm socket wrench to loosen the 4 screws that secure the fan to the casing.



11. Take a small slotted screwdriver and carefully lift the fan off the seal at one corner.



12. Once the seal on the fan is removed, lift the fan off and set it aside.

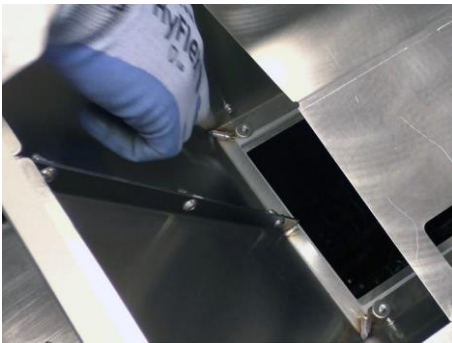

13. Attach the PVF casing to the top of the appliance with the previously removed washers and screws, using a 13 mm socket wrench.

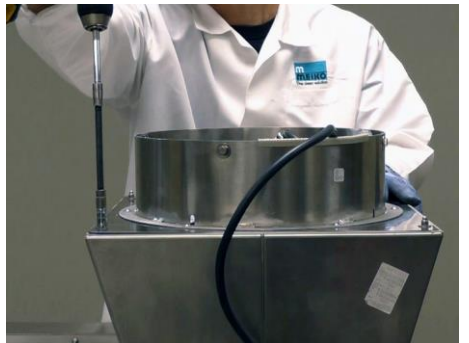

14. Place the fan back on the casing, replace the screws and tighten them with a 13 mm socket.



15. Remove the rack from the machine and locate the bag containing the assembly parts in the rack.



16. Take 2 stiffening brackets, 2 countersunk screws, 2 rosettes and the sliding plate out of the bag.



17. Replace the top cover by sliding it around the PVF and snapping it firmly into place.

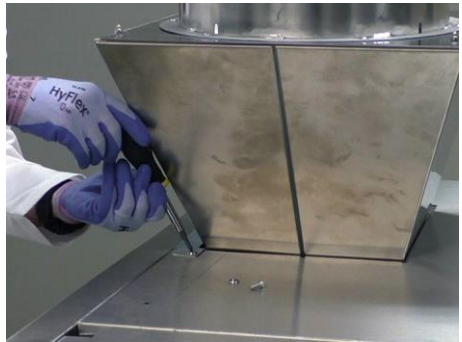

18. Align the two holes on the top plate and the stiffening bracket and secure them with the countersunk screws and rosettes.

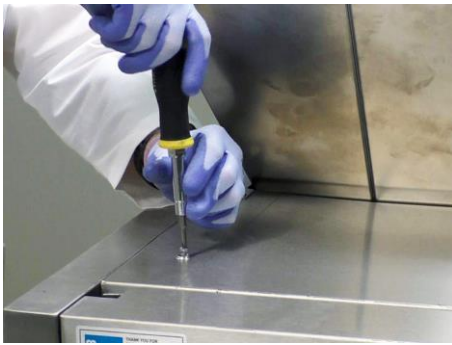

19. Reattach the top cover with the previously removed screws.

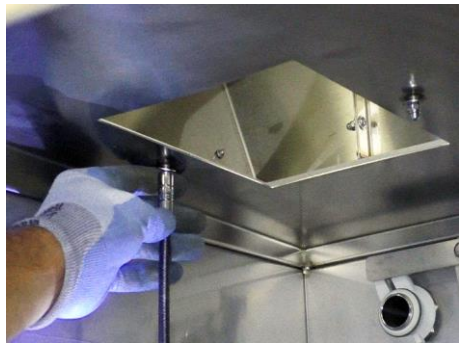

20. Remove the 2 screws and washers from the fan opening inside the appliance using a 13 mm socket wrench.

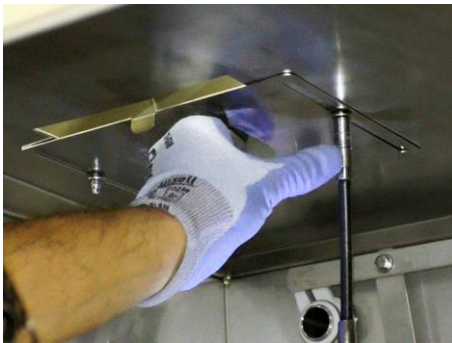

21. Take the sliding plate, place the slots over the screw bolts and loosely reattach the washers and screws.

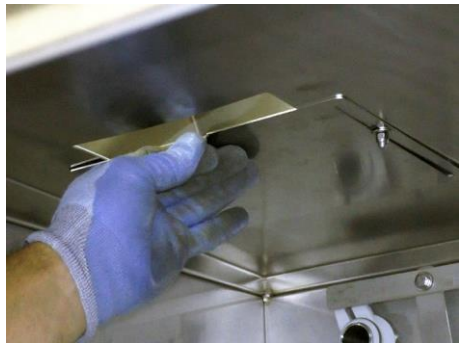

22. Adjust the sliding plate to the desired opening by sliding it back and forth.

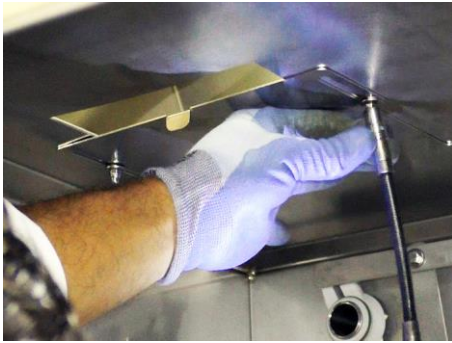

23. Tighten the screws to secure the sliding plate.



24. Locate the end of the power cable for the PVF.

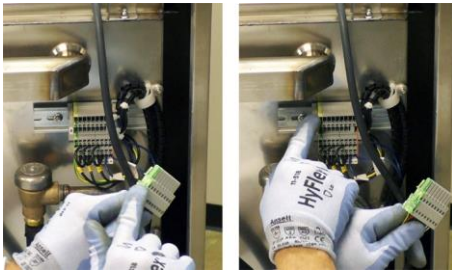

25. Align the earthing side of the plug with the earthing connection block.



26. Press the plug into the top row of the connection block until it snaps into place.

### 8.3 Accessing the utility connections

In order to attach the machine's electrical supply connections, the front panel must be removed.

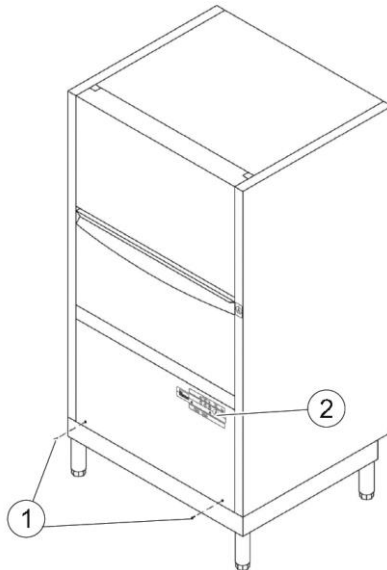

1. Remove and retain the two screws on the bottom of the front panel (1).
2. Slide the front panel down and away from the machine to remove.
3. When removing the front panel, disconnect the ribbon cable (2) for the MIKE 2 controller to avoid damage.

### 8.4 Electrical installation



#### **WARNING – Danger to life from electric shock**

- Work on the electrical system must only be conducted by qualified personnel who comply with the electrotechnical rules.
- Disconnect the machine from the power supply before removing any casing parts or working on the electrical system. To do this, turn the local main switch to **OFF** and ensure that it cannot be switched back on again.
- Attach all housing parts again before switching on the voltage again.

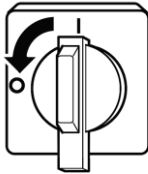

1. Turn the local main switch to OFF and ensure that it cannot be switched back on again.
2. Check whether the supply pipes are sufficiently dimensioned for the machine's current consumption. The amperage and minimum supply pipe requirements are indicated on the rating plate and on the electrical data label.

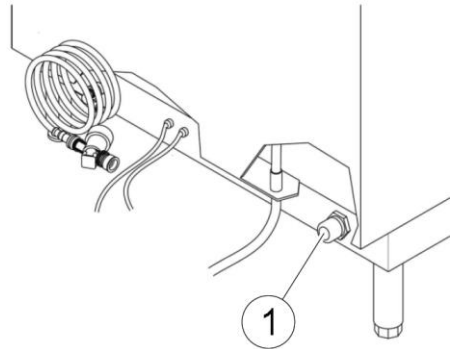

3. Route the electrical supply line through the strain relief (1) and to the electrical box.
4. Check that the electrical supply line is long enough to allow the machine to be repositioned for subsequent maintenance.
5. Fasten the supply line using the strain relief (1). You should leave enough slack in the supply line to prevent stress on the connections.

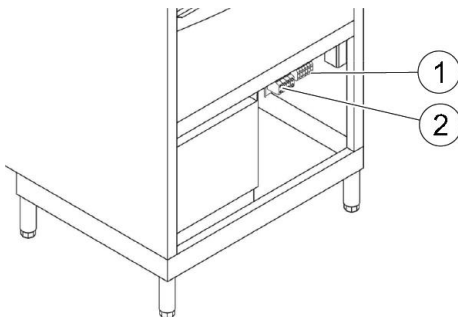

6. The main terminals (2) are located in the electrical box. Terminals for EVFC connection (1).

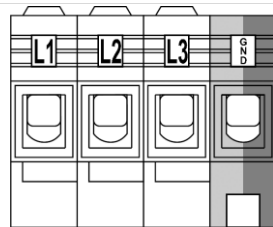

**208-230 V, 60 Hz, three phase**  
or

**460 V, 60 Hz three phase**

L1, L2, L3 = "hot" (line)

yel/grn = ground

7. Connect the supply line in accordance with the figure and the wiring diagram.

## Line voltage for Exhaust fan (Option)

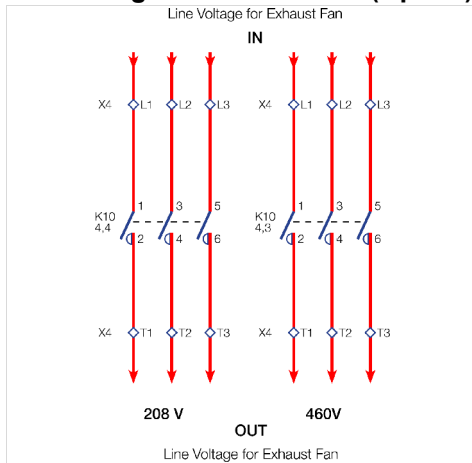

### Terminal:

- Screw torque: 0.8 ... 1.0 NM
- Solid/fine-stranded conductor 0.5 ... 6 mm<sup>2</sup> / 22 ... 8 AWG
- Strip length 12 mm / 0.47 inch
- To connect the wires to the terminals for the on-site ventilation system, the front panel must be removed.

### Strain relief:

- Clamping range of the strain relief from 11-21 mm / 0.43-0.83 inch: minimum outer diameter of the connection line 11 mm / 0.43 inch, maximum outer diameter of the connecting line 21 mm / 0.83 inch
- The strain relief must be tightened to withstand a direct pulling force of 156 NM / 35 lb (156 N) applied for 1 minute, without any displacement, in accordance with UL 921

### Supply connection:

- Flexible cords and cables shall comply with CSA C22.2 No. 49 and UL 62 and shall be Type S, SE, SO, SOO, ST, STO, or STOO
- The on-site ventilation system must be connected to the equipotential bonding. All power supply connections must be made in accordance with „UL Standard for Safety for Commercial Dishwashers, UL 921, Eighth Edition, Dated January 30, 2020“ section „4.7 Powersupply connections“.

## Protective equipotential bonding

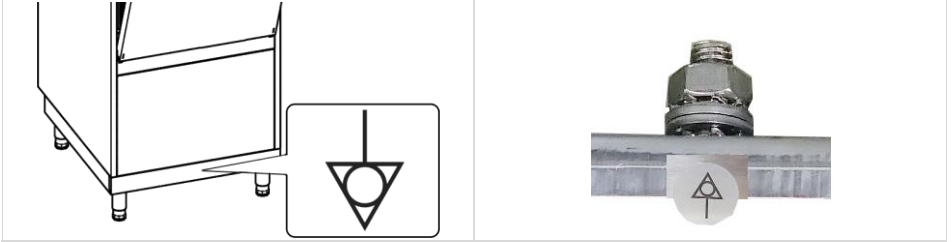

The screw for the equipotential bonding is located on the front of the machine behind the front panel.

## 8.5 Connecting the fresh water pipe

### NOTE

#### Damage to property due to deposits

Deposits in the fresh water supply (tube sealant, metal particles, soldering agent, etc.) can result in damage to the machine.

- Prior to connection, thoroughly flush the fresh water pipe using fresh water.



### IMPORTANT

The fresh water pipe must be sufficiently long so that the machine can be moved for servicing purposes.

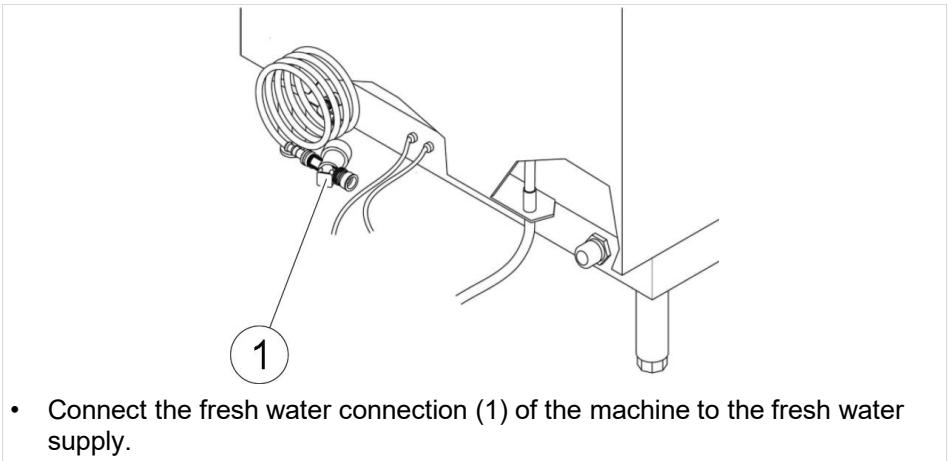

- Connect the fresh water connection (1) of the machine to the fresh water supply.

## 8.6 Connecting the wastewater pipe

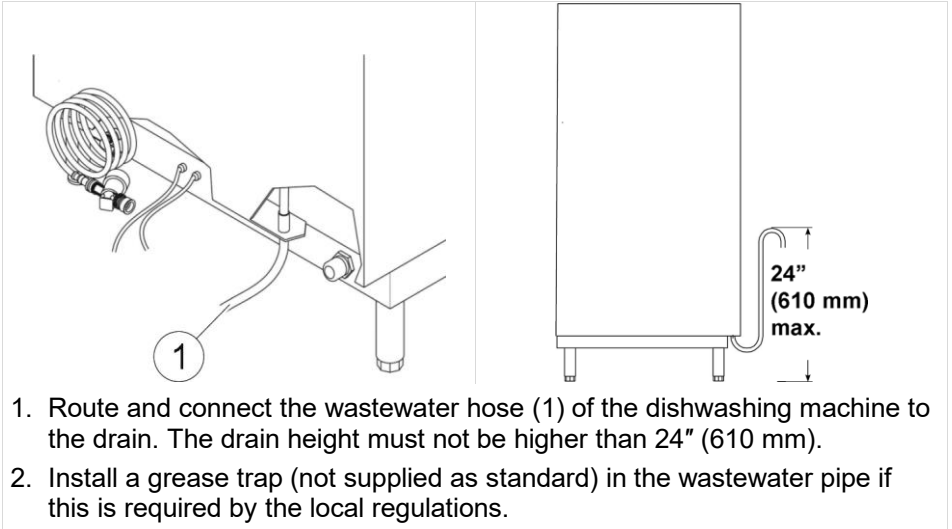

## 8.7 Connection for wastewater temperature control (optional)

The wastewater can have a temperature of more than 150 °F (65 °C). Install a temperature conditioning kit if a lower wastewater temperature is required by local regulations.

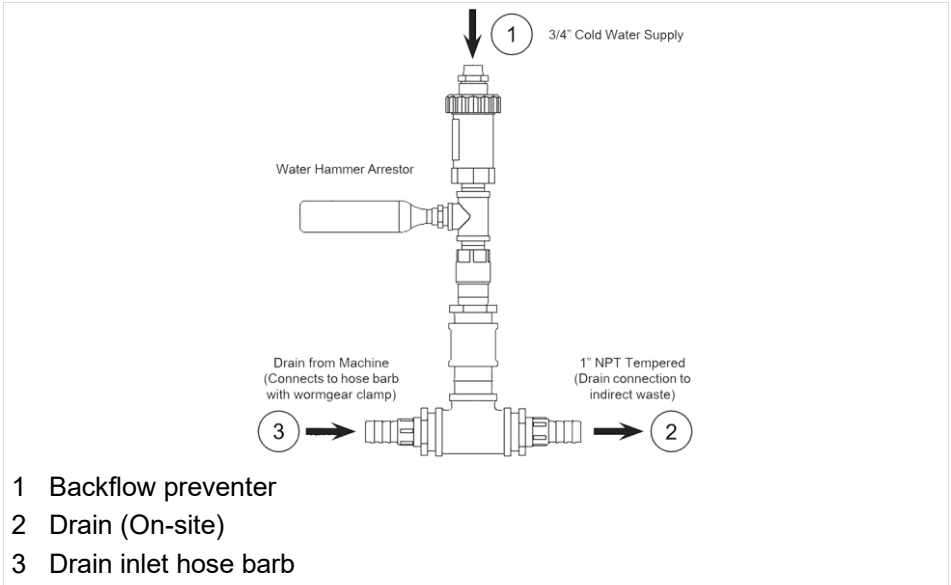

### Connection procedure:

1. Position tempering assembly, as required, behind the machine..
2. Connect **cold water supply line** to the backflow preventer (1), using a 1/2" pipe fitting. If you are soldering, be sure to remove the union on the backflow preventer. This will insure that the plastic internal parts do not melt.
3. Connect from drain (2) of the tempering assembly to an indirect waste drain pipe. If required, the 1" barb can be removed and the drain can be connected using 1" fittings and pipe.
4. Connect drain hose from the machine to the drain inlet hose barb (3) and secure with wormgear clamp.
5. Turn on **cold water** and check for leaks.
6. Fill machine and operate. The drain water exiting the drain water tempering assembly (2) should be no higher than 140 °F (60 °C).

## 8.8 Connecting the dosing system

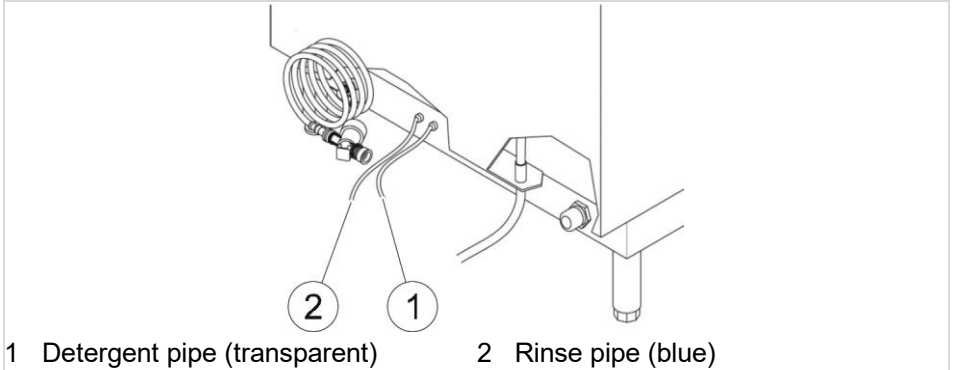

The FV 130.2 is designed for use with liquid detergent and liquid rinse aid. All versions are equipped with internal dosing units for liquid detergent and rinse aid and two feed hoses (1, 2) exiting from the lower rear of the machine. These hoses can be easily connected to the canisters for detergent and rinse aid.



### NOTE

If you wish to use an external chemical dosing system, please contact the MEIKO subsidiary for additional instructions and requirements.

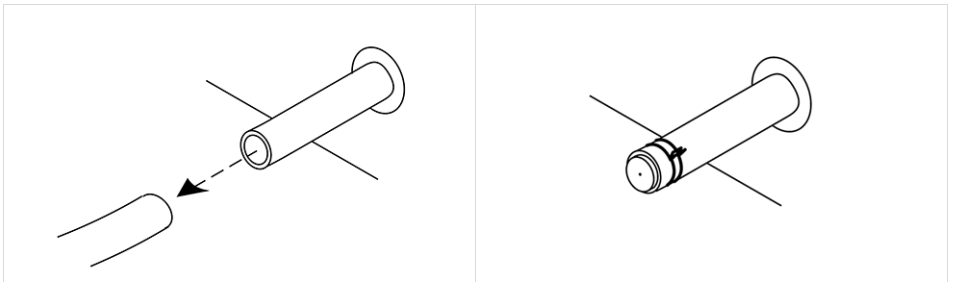

### CAUTION

If one or both dosing pipes are not used, cut the relevant dosing pipe(s) near the exit point from the machine and seal using the supplied plug and the wire clip.

## 8.9 Connecting the detergent and rinse aid canisters



### WARNING – Risk of injury from contact with chemicals

- Observe the safety data sheets and dosing recommendations of the chemical manufacturers.
- Use safety eyewear.
- Wear protective gloves.
- Do not mix different chemical products.

1. Ensure that the rinse aid/detergent is compatible with the machine. In particular, use a commercial, low-foaming detergent suitable for commercial dishwashers.
2. Check that the canisters/dispensers are correctly installed according to the manufacturer's instructions.

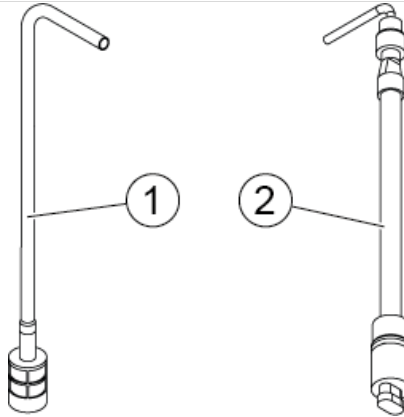

3. Insert the rinse aid suction lance (1) and the detergent suction lance (2) in the corresponding canister.
4. Slide the rinse aid hose (blue) and the detergent hose (transparent) onto the associated suction lance hoses. The suction lances must be inserted so that they are completely at the bottom.
5. Clamp the two hoses using a collar clamp.

## 8.10 Terminating the installation

1. Check and tighten all screws of the electrical connections.
2. Reattach all housing parts to the machine.
3. Set the circuit breaker/fuse disconnect switch to ON.
4. Vent the detergent and rinse aid dosing units, see page 46.

**For disposal of packaging materials, see page 22!**

## 9 Commissioning



### **WARNING – Danger of injury when entering a danger zone**

- Only qualified personnel may work on the machine.
- Remove unauthorized persons from the danger zone.
- Block off the danger zone and mark it for third parties.
- Always wear cut-resistant protective gloves when removing casing parts or working inside the machine.

### 9.1 Checking the requirements for commissioning

#### **NOTE**

#### **Damage to property due to steam emission**

Small quantities of steam may escape from the machine. It is possible that adjacent furniture swells.

- Protect adjacent furniture from swelling.
- If possible, avoid installing the machine in an area close to furniture susceptible to swelling.

Requirements to be provided by the customer:

- Consistently frost-free storage and installation area.
- Anti-slip floor coverings provided in the work area around the machine.
- All connections are made correctly as described above.

## 9.2 Performing commissioning

To avoid damage or injuries during machine commissioning, please note the following points:

- Check supplier parts (e.g. external water handling devices). More detailed information can be found in the relevant operating instructions.
- Ensure that all tools and foreign parts are removed from the machine.
- Check if all casing parts are mounted on the machine.
- Turn on the main switch.
- Vent the pipes for the chemicals and check for correct dosing.













## 9.3 Venting (priming) the pipes

Venting of the detergent or rinse pipes must be performed during commissioning to fill the pipes with detergent and rinse aid.

The pipes must also be vented if the dosing units have sucked in air. This occurs if a canister is completely emptied during operation, or if one of the suction lances was not inserted all the way to the bottom of the canister.

For machines with external dosing systems, the detergent and rinse pipes must be vented in accordance with the manufacturer instructions.

For machines with built-in dosing systems, vent the pipes as follows:

 	<p>1. Press the STOP key for approx. 5 seconds until CodE 1- - - - is displayed.</p>
 	<p>2. Press the START key 5 times until 1-1 - - - - is displayed.</p>
 	<p>3. Press program key I. 1-2 - - - - is displayed.</p>
 	<p>4. Press the START key. Priming of the rinse pipe will start. The time remaining is displayed. By default, priming takes 180 seconds.</p>
 	<p>5. If the time has expired and 1-2 - - - - is displayed, press program key I. 1-3 - - - - is displayed.</p>
 	<p>6. Press the START key.</p>

	<p>Priming of the detergent pipe will start. The time remaining is displayed. By default, priming takes 30 seconds.</p>
	<p>7. If the time has expired and 1-3 - - - - is displayed, press the STOP key to switch the machine off.</p>

## 10 Operation/use

### 10.1 Prior to switching on the machine



#### **WARNING – Risk of injury from contact with chemicals**

- Observe the safety data sheets and dosing recommendations of the chemical manufacturers.
- Use safety eyewear.
- Wear protective gloves.
- Do not mix different chemical products.

The dishwasher may only be used if the operating instructions have been read and understood. Incorrect operation may result in personal injury or damage to property.

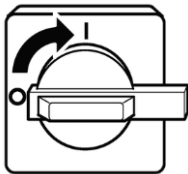

1. Turn on the main switch.

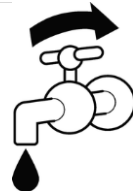

2. Turn on the tap.

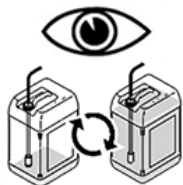

3. Check the detergent and rinse aid and replace in accordance with the manufacturer instructions, if necessary.

#### NOTE

If there is air in the hoses, the dosing function will not work properly. The hoses must be vented, see page 46.

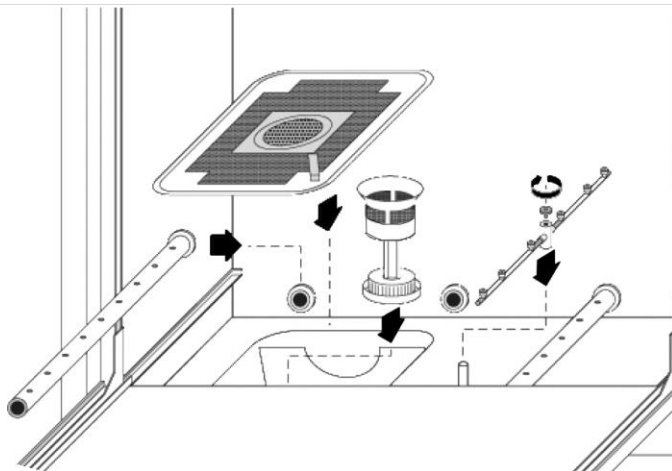

4. Insert the filter, tank cover sieve, wash pipes and top and bottom rinse arms.
5. Close the door.

### 10.1.1 Starting up the dishwasher

The time required for the machine to be ready to operate depends on the temperature of the supplied water and the capacity of the installed boiler or tank heating.



The dishwasher is closed and does not have a rack inside.

1. Press **wash program keys 1, 2, or 3.**



The dishwasher will be filled and heated up. During this time, the control light above the selected program key flashes.



When the machine is ready to operate, the control light above the selected program key is permanently on.

## 10.2 Washing

### 10.2.1 Useful information for loading the washware

- ▶ Remove large residues (food, pastry, etc.).
- ▶ Pour leftover drinks into the sink.
- ▶ Soak cutlery and kitchen utensils until they are washed.
- ▶ Pre-clean all parts with the spray before the rack is pushed into the machine.

### Examples

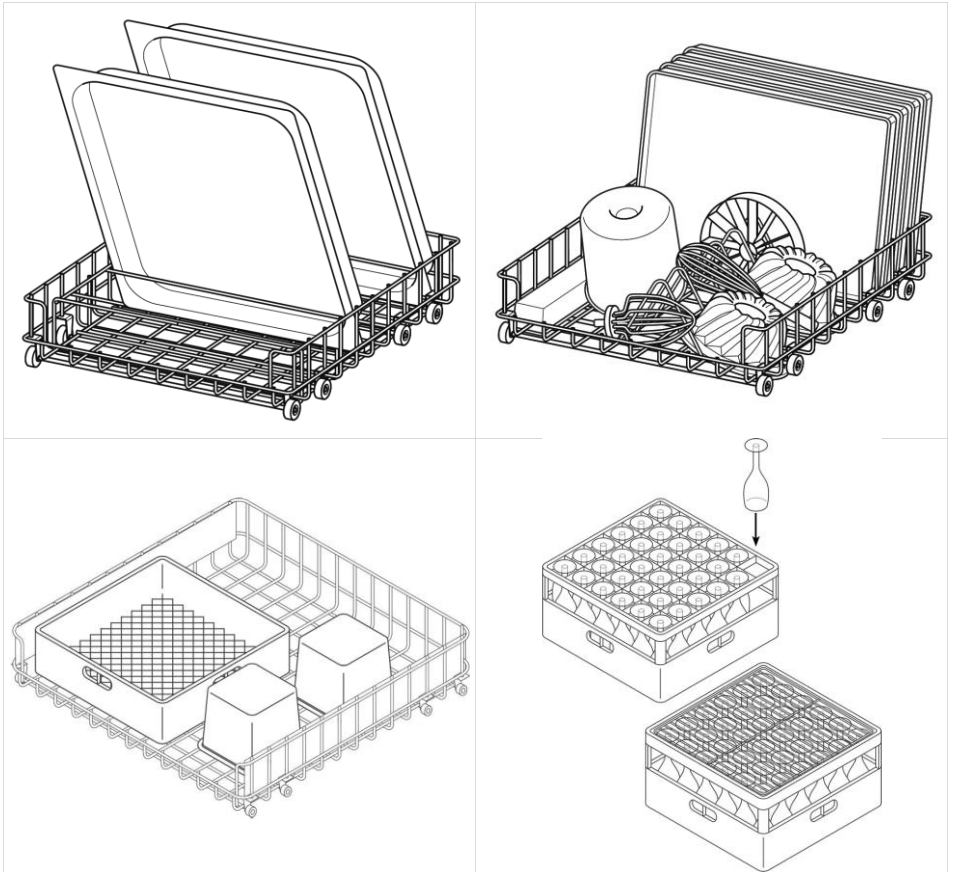

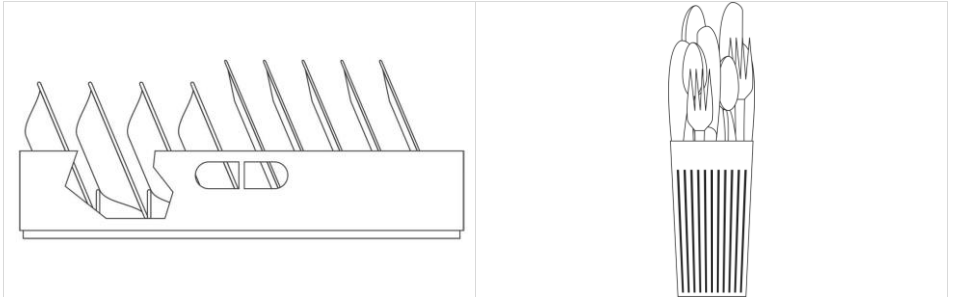

- Plates, soup bowls and glasses can be placed in the machine using a standard 20x20" rack. A standard rack fits in the large rack, with space for additional utensils.
- Always load hollow containers upside down. Otherwise, the water will not be drained from the washware and brilliant drying will not be possible.
- Keep a space between the hollow containers so that they do not rub against each other. This prevents scratches.
- Either use a rack with a hold-down device or a large rack with divisions for washing glasses.
- Place plates, trays, and dishes into the racks at an angle. The inner surfaces face upwards.
- If cutlery quivers are used, always load the cutlery pieces with the handles down.
- Load an assortment of spoons, knives, and forks into each cutlery quiver, as identical cutlery often is too closely spaced.
- Do not overload the individual cutlery quivers.
- Do not stack washware in the rack. Direct contact with the wash water would be more difficult and a longer program duration would need to be selected. It is more efficient to load the rack with fewer items and run shorter wash cycles.

## 10.2.2 Selecting the wash program

The time required for the machine to be ready to operate depends on the temperature of the supplied water and the capacity of the installed boiler or tank heating.



The dishwasher is closed and does not have a rack inside.

1. Press **wash program keys 1, 2, or 3**.



The dishwasher will be filled and heated up. During this time, the control light above the selected program key flashes.



When the machine is ready to operate, the control light above the selected program key is permanently on.



- Press the required program key.



The control light of the selected program key is on.

### 10.2.3 Starting the wash cycle

#### Pre-washing



- Dispose of leftovers and waste separately, empty liquids into the sink.
- Remove larger pieces as well as possible.

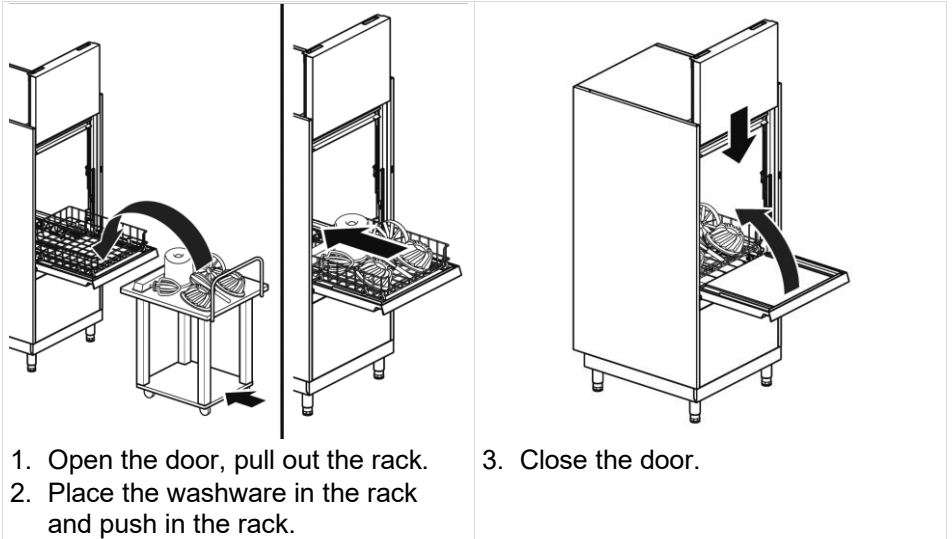

1. Open the door, pull out the rack.
2. Place the washware in the rack and push in the rack.

3. Close the door.



4. Change the program, if required, see page 52.

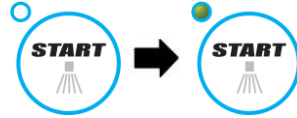

5. Press the **START** key.  
The control light is on as long as the program is active.

If the selected program is not long enough to heat up the boiler and tank water to the minimum temperature, the program duration must be extended. The program runs until the minimum temperatures are reached, but for a maximum of 5 minutes.

#### 10.2.4 Unloading the washware



**CAUTION – Danger of burns from hot wash water, hot washware and hot machine parts**

- Wear protective gloves, if necessary.
- Let the washware cool down before emptying, if necessary.
- Let the machine cool down before touching machine parts, if necessary.
- Never open the door during a wash cycle.
- Only open and close the door using the designated handle(s).

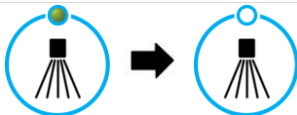

At the end of the program, the control light turns off and an acoustic signal sounds.

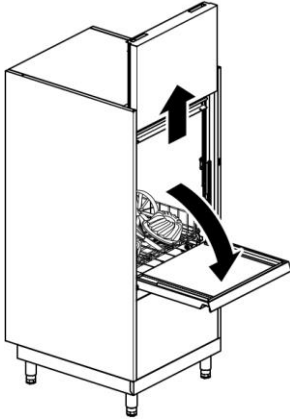

1. Open the door.

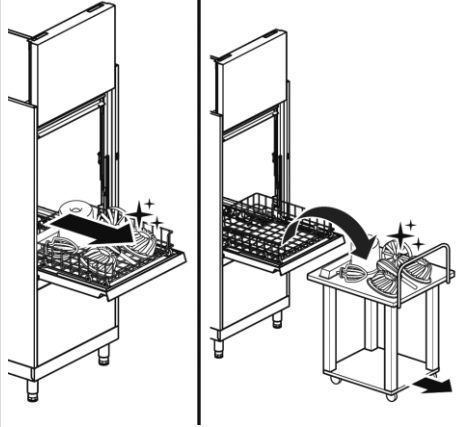

2. Pull out the rack and remove the washware.

3. Close the door.

### 10.3 Switching off the machine



#### **WARNING – Risk of injury from contact with chemicals**

- Observe the safety data sheets and dosing recommendations of the chemical manufacturers.
- Use safety eyewear.
- Wear protective gloves.
- Do not mix different chemical products.



#### **WARNING – Danger of scalding**

- Do not open the door during self-cleaning.

**The dishwasher is closed and does not have a rack inside.**



1. Press the **STOP** button.  
All control lights turn off.



2. Press the **START** key.



The self-cleaning program starts. The control light on the **START** key flashes. The wash water is pumped out and the wash chamber is sprayed with hot fresh water.

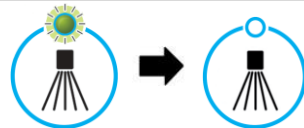

At the end of the program, the control light turns off. Now, the machine can be cleaned, see page 67.

## 10.4 Replacing the canisters



### WARNING – Risk of injury from contact with chemicals

- Observe the safety data sheets and dosing recommendations of the chemical manufacturers.
- Use safety eyewear.
- Wear protective gloves.
- Do not mix different chemical products.

Info

420

Rinse aid empty

Info

520

Detergent empty



#### IMPORTANT

The canisters for detergent and rinse aid are located in close proximity to the dishwasher.



#### IMPORTANT

When using a suction lance that detects whether a canister is empty, shortage of detergent or rinse aid will be indicated on the display.

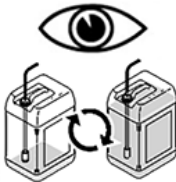

1. Remove the suction lance from the empty canister and insert it into a full canister.

2. If air has been sucked in: vent the pipes, see page 46.

## 10.5 Malfunctions

Many malfunctions can be rectified without the help of the customer service. The following malfunctions can be remedied by the operating personnel or the in-house technician.

### Common malfunctions

Malfunction	Possible cause	Remedy
Dishwasher not filling up	No water available	Open shut-off valve
	Dirt trap clogged	Clean dirt trap
	Door open	Close door
Final rinse not spraying	No water available	Open shut-off valve
	Dirt trap clogged	Clean dirt trap
Streaks/smears on washware	Inappropriate rinse aid	Change product
	Incorrect dosing quantity	Adjust dosing quantity
	Water pre-treatment defective	Check water pre-treatment
Bubbles and streaks on washware	Overdosing	Have the dosing quantity adjusted
Water drops on washware	Underdosing	
Strong foam formation in wash tank	Dirt level too high	Pre-wash washware more thoroughly/change tank water more frequently
	Hand dishwashing detergent used	Do not use a foaming hand dishwashing detergent for pre-cleaning or for cleaning the machine. Foam can cause malfunctions in the dishwasher and poor washing results.
	Inappropriate detergent	Change product
	Inappropriate rinse aid	

Please contact your authorized MEIKO customer service if the listed measures cannot solve the problem.

For a list of authorized customer service points, please either scan the QR code on the back cover of these operating instructions, visit our website at [www.meiko.us](http://www.meiko.us) or give us a call at (800) 868-3840.

### 10.5.1 Messages



When a malfunction occurs, an information or error message (**INFO/ERR**) is displayed.

- Information messages (**INFO**) can be acknowledged using the START key. If the cause has been remedied (see table), operation can be continued.
- Error messages (**ERR**) usually require the deployment of an authorized service technician.
- If the machine displays an information or error message not listed in the following tables, contact your service technician.

INFO	Description	Possible cause	Measures/remedy
120	Emergency program active	No boiler/tank heating No fresh water supply	Further operation possible with restrictions Call service technician
121	Door not closed	Door open I/O circuit board defective Microswitch defective Microswitch not set correctly	Close door Call service technician
122	Incorrect password/no authorization	Code entered incorrectly	Enter code again
123	Factory settings of parameter list	Switching supply voltage on/off	No intervention by operator necessary Message disappears after 5 min.
126	Maintenance required	Set operating hours (P 122) or batch number (P 123) has been reached	Further operation possible Call service technician

<b>INFO</b>	<b>Description</b>	<b>Possible cause</b>	<b>Measures/remedy</b>
325	Drain pump active after triggering of safety level	Wash tank overfilled	Wait until machine is drained
420	Lack of rinse aid (with fill-level detection integrated)	Canister empty Suction lance not inserted correctly	Replace empty canister Check suction lance Vent pipes, if necessary
520	Lack of detergent (with fill-level detection integrated)		

<b>ERR</b>	<b>Description</b>	<b>Possible cause</b>	<b>Measures/remedy</b>
001	EEPROM error	EEPROM not available/defective, incorrectly plugged in, incorrect data, empty	Further operation not possible Call service technician
111	Leakage in base drip tray	Leak in feed hose Drain hose not connected correctly to drain	Replace feed hose, if necessary Check drain hose
118	Signal of the two door contact switches not the same	Malfunction/defect of door contact switch	
201	Boiler level not reached during first filling (with pressure booster pump integrated)	Fresh water supply not sufficient (water supply valve closed) Feed hose	Check water supply Check feed hose Check pre-filter/strainer and clean, if necessary Call service technician, if necessary
202	Boiler level not reached on time during filling (with pressure booster pump integrated)	kinked/loose/leaking Incoming water strainer dirty Solenoid valve defective Boiler switch defective	
203	No change detected at boiler level switch when emptying (with pressure booster pump integrated)	Pressure booster pump defective Connections (e.g. pressure booster pump) loose Starting capacitor defective	Further operation not possible Call service technician
204	No change yet detected at boiler	Boiler level switch defective No signal for pressure	

<b>ERR</b>	<b>Description</b>	<b>Possible cause</b>	<b>Measures/remedy</b>
	level switch (with pressure booster pump integrated) after rinse time expired	booster pump on - from I/O circuit board No signal for boiler full - from I/O circuit board	
205	Boiler temperature not reached after max. heating time (P310)	Boiler heating defective/welding beads on heater Temperature sensor defective, incorrect mounting position Boiler contactor defective, circuit breaker triggered No signal from I/O circuit board	Further operation not possible Call service technician
206	Wash time increase	Boiler not ready on time for final rinse (temperature or level not reached) Boiler heating defective (welding beads) Temperature sensor defective Boiler contactor defective, circuit breaker triggered No signal from I/O circuit board	Acknowledge message, further operation possible Allow the program to end without operator intervention Call service technician if this occurs more often
210	Short-circuit of boiler temperature sensor	Sensor defective Sensor position not correct	Further operation not possible Call service technician
211	Interruption of boiler temperature sensor	Plug contact not connected properly	
212	"Actual" boiler temperature too high (>203°F)	Contactors contact sticking Incorrect sensor/defective sensor	
301	Number of circulatory pumping cycles for tank filling exceeded Tank level analysis disrupted	Supply water pressure too low Incoming water strainer dirty Rinse nozzles dirty Air gap dirty Condensate in level pipe Feed hose kinked/loose/leaking	Check water supply Check feed hose Clean incoming water strainer Clean rinse nozzles Call service technician, if necessary

<b>ERR</b>	<b>Description</b>	<b>Possible cause</b>	<b>Measures/remedy</b>
302	While draining during the wash program, the level does not fall below tank level 1 on time (with drain pump integrated)	Capacity of drain pump too low Drain pump dirty/defective Impeller loose Connections of drain pump loose	Further operation not possible Call service technician
303	While draining during the wash program, the level does not fall below tank level 3 on time (with drain pump integrated)	Starting capacitor defective, tank level analysis disrupted Aquastop does not close correctly No signal from I/O circuit board	Call service technician
304	Tank temperature not reached after max. heating duration (P314)	Tank heating defective/welding beads on heater Temperature sensor defective, incorrect mounting position Tank contactor defective, circuit breaker triggered	Further operation not possible Call service technician
305	Number of boiler fills insufficient for rinsing. Tank level 2 not reached	Supply water pressure too low Incoming water strainer dirty Rinse nozzles dirty Air gap dirty Condensate in level pipe Feed hose kinked/loose/leaking Level sensor defective Plug contact not connected properly	Check water supply Check feed hose Clean incoming water strainer Clean rinse nozzles Call service technician, if necessary
306	Max. tank level exceeded. Tank level analysis disrupted	Air gap dirty Condensate in level pipe Level sensor defective Plug contact not connected properly	Drain dishwasher and refill Call service technician
307	Tank level sensor defective	Connector loose Sensor or I/O circuit board defective	Call service technician





<b>ERR</b>	<b>Description</b>	<b>Possible cause</b>	<b>Measures/remedy</b>
310	Short-circuit of temperature sensor	Sensor defective	Further operation not possible Call service technician
311	Interruption of temperature sensor	Sensor position not correct Plug contact not connected properly	
312	Actual tank temperature too high (>185°F)	Contacting contact sticking Incorrect sensor/defective sensor	



Please contact your authorized MEIKO customer service if:

- There is an issue with the dishwasher, but no error code is displayed, OR
- An error code is displayed that is not listed here, OR
- The listed measures cannot solve the problem.



For a list of authorized customer service points, please either scan the QR code on the back cover of these operating instructions, visit our website at [www.meiko.us](http://www.meiko.us) or give us a call at (800) 868-3840.

## 10.6 Modifying the settings

Key	Meaning	Key	Meaning
	<b>STOP key</b> <ul style="list-style-type: none"> <li>Starts programming</li> </ul>		<b>START key</b> <ul style="list-style-type: none"> <li>Confirms entry and jumps to next position in the code</li> </ul>
	<b>Program key 1</b> <ul style="list-style-type: none"> <li>Increases value by one</li> </ul>		<b>Program key 2</b> <ul style="list-style-type: none"> <li>Decreases value by one</li> </ul>

1. Press the **STOP key** for approx. 5 seconds until **CodE 1- - - -** is displayed.

2. Enter the code for the required level. For level 1, it is sufficient to press the **START key** 5 times.

**Level 1: Advanced settings (code 11111)**

**Level 2: Dosing settings (code 40044)**





After entering the correct code, the desired level (1, 4) is displayed in the left field at the first digital position.









If the entry is incorrect, the **Info 122** message appears.













## 10.7 Level 1 - User settings (Code 10001)

Code display	Meaning
	View parameter, see page 65.
	Vent (prime) rinse pipe, see page 65.
	Vent (prime) detergent pipe, see page 65.

### 10.7.1 Viewing the parameters

 <p>1. Switch to <b>level 1 (11111)</b>, see page 64.</p>	 <p>2. Select entry 1–1.</p>
 <p>3. Confirm the selection.</p>	 <p>The first parameter is displayed.</p>
 <p>4. Scroll through and view the parameters using the wash program keys.</p>	 <p>Level 1 can be exited with the <b>on/off key</b>.</p>

### 10.7.2 Venting (priming) the pipes

 	<p>1. Press the STOP key for approx. 5 seconds until <b>CodE 1- - - -</b> is displayed.</p>
 	<p>2. Press the START key 5 times until <b>1-1 - - - -</b> is displayed.</p>
 	<p>3. Press program key I. <b>1-2 - - - -</b> is displayed.</p>
 	<p>4. Press the START key. Priming of the rinse pipe will start. The time remaining is displayed. By default, priming takes 180 seconds.</p>
 	<p>5. If the time has expired and <b>1-2 - - - -</b> is displayed, press program key I. <b>1-3 - - - -</b> is displayed.</p>
 	<p>6. Press the START key. Priming of the detergent pipe will start. The time remaining is displayed.</p>

	By default, priming takes 30 seconds.
	7. If the time has expired and 1-3 - - - is displayed, press the STOP key to switch the machine off.

## 10.8 Level 2 - Dosing system settings (Code 40044)

Switch to level 2 (40044), see page 64.

The parameters relevant for the dosing technology are displayed and can be changed.

Para.	Definition	Adjustment range / Setting
<b>P104</b>	Dosing quantity for rinse aid	0.10–1.00 ml/l (0.20 is the default setting)
<b>P105</b>	Dosing quantity for detergent	0.10–20.0 ml/l (2.00 is the default setting)
<b>P218</b>	Lack of rinse aid indication	1/0 = Display on/off ( <b>Note: must be set to 0</b> )
<b>P219</b>	Lack of detergent indication	1/0 = Display on/off (1 is the default setting)
<b>P224</b>	Activation mode for rinse aid dosing unit	0 = Do not activate ( <b>Should only be selected if not using rinse aid!</b> ) 1 = Activate through calculated runtime (default setting) <b>Note: settings 2 or 3 must NEVER be used on this model!</b>
<b>P225</b>	Activation mode for detergent dosing unit	0 = Do not activate 1 = Activate through calculated runtime 3 = Activate like wash pump ( <b>only used if utilizing an external dispensing system</b> ) <b>Note: Setting 2 must NEVER be used on this model!</b>
<b>P321</b>	Capacity of rinse aid dosing unit	0.10–10 l/h - <b>Must be set to 1.3 l/h</b>
<b>P322</b>	Capacity of detergent dosing unit	0.10–20 l/h - <b>Must be set to 7.0 l/h</b>
<b>P326</b>	Vent (priming) time for rinse pipe	0–255 s (180 s is the default setting)
<b>P327</b>	Vent time (priming) for detergent pipe	0–100 s (30 s is the default setting)

## 11 Cleaning the machine

The headings **Daily Cleaning** and **Weekly Cleaning** in this section are general recommendations based on typical soiling. Because of the large quantity of food soiling present on many pots and pans, it may be necessary to clean the machine more often and more extensively than a traditional dishwasher. Extensive food soil deposits inside the machine work against optimal performance. Some items may not be cleaned as effectively, resulting in the need for either a longer cycle or repeat washing. In addition, heavy soiling in the wash water increases detergent consumption.



### **CAUTION - Danger of burns from hot machine parts**

- Allow the machine to cool down before cleaning.
- Wear protective gloves, if necessary.
- Only use the handles provided for opening or closing.



### **CAUTION – Property damage to electrics due to water ingress**

- The machine, control cabinets and other electrical components must never be sprayed with a hose, a high pressure cleaner or a steam cleaner.
- Make sure that no water can enter the machine unintentionally.
- If installed at ground level, never flood the surrounding room.



### **IMPORTANT**

Do not use a foaming hand dishwashing detergent for pre-cleaning the dishes. Do not use detergents or stainless steel cleaning agents on the interior of the machine. Foam causes malfunctions and poor washing results.

### **IMPORTANT**

**Daily cleaning** and **weekly cleaning** in this section are general recommendations based on typical soiling.

## 11.1 Daily cleaning



1. Switch off and drain the machine, see page 56.

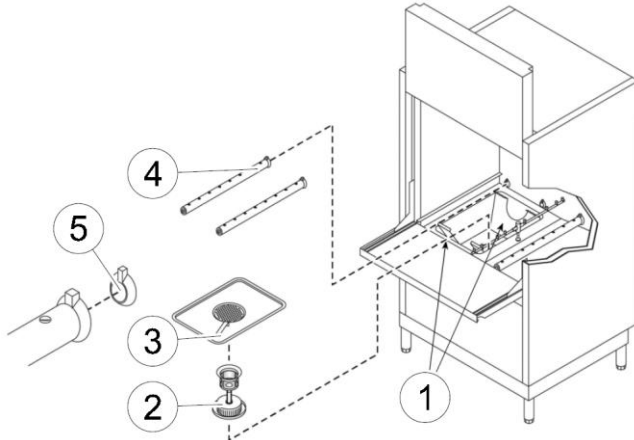

2. Open the door and remove the rack after the self-cleaning program. Any remaining food waste and dirt can be removed with a soft, damp cloth.
3. Remove the two lower left-hand wash pipes (4) to gain access to the tank cover sieve and tank. To remove the wash pipe (4), start by pulling its front upwards and out of the black retaining bar. Then pull the back out of the distributor (5).
4. Remove all large food particles, residues or bones from the dirt filter (3).
5. Lift out the dirt filter (3) and clean thoroughly with a brush and hot water.
6. Fold up the two angled plates (1) surrounding the AktivPlus filter (2).
7. Remove the AktivPlus filter (2). Clean thoroughly with a brush and hot water. Make sure that the sieve of the AktivPlus filter (2) is not damaged.
8. Check the inside of the tank for food residues. Remove all residues from the tank by wiping them away with a clean, damp cloth.
9. MEIKO recommends leaving the door open overnight to allow the machine to air out well.
10. Reinstall all components before switching the machine back on. Note the following:

- The AktivPlus filter (2) **must** be reinstalled with the slotted end pointing **downward**.
- Fold down the two angled plates (1) surrounding the AktivPlus filter (2) before reinserting the dirt filter (3).
- To insert the wash pipes (4), start by inserting the back end into the distributor (5). The back end of the arm has wedges to ensure correct positioning. Then snap the front end into the black retaining rod. All lower wash pipes are identical.

## 11.2 Weekly cleaning

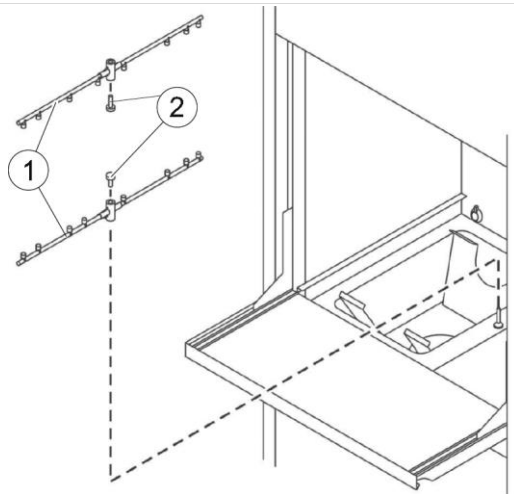

Perform the following steps at least once per week:

1. Open the door. Follow the procedure for daily cleaning, see page 68.
2. Remove and disassemble the wash pipes and rinse arms. The machine is equipped with:
  - Four upper wash pipes (identical)
  - Four lower wash pipes (identical)
  - One removable upper rinse arm (1) with locating screw (2)
  - One removable lower rinse arm (1) with locating screw (2)
  - Two additional fixed lower wash pipes (these stay where they are)
3. Clean the wash pipes and rinse arms with a brush under hot running water. In particular, make sure that all food residues in the wash pipes are removed.

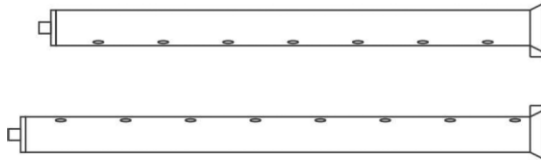

4. Reinstall all parts in the machine. Make sure that the shorter wash pipes are installed at the top and the long wash pipes at the bottom.

The two removable rinse arms are identical. The upper wash arms are slightly shorter than the lower ones to ensure they are not reinstalled in the wrong place.

All lower wash pipes are removed in the same way, as described in the section Daily cleaning. To remove the upper wash pipes, start by pulling the front of the arm down and out of the black retaining rod, and then pull the back out of the distributor.

To remove the rinse arms, remove the retaining screw and pull the arm off the shaft.

### 11.3 Cleaning the membrane keypad

Clean the membrane keypad using a damp cloth.

**IMPORTANT** - Make sure that the membrane keypad does not contact any stainless steel cleaning agents as this may result in damage to the membrane keypad.

### 11.4 Cleaning outer stainless steel surfaces



#### **CAUTION – Property damage to stainless steel due to incorrect cleaning**

Cleaning of stainless steel parts using inappropriate detergents, care products and cleaning utensils leads to damage, deposits or discoloration on the machine.

- Never use aggressive detergents or abrasives.
- Never use detergents that contain hydrochloric acid or chlorine-based bleachers.
- Do not use cleaning utensils previously used to clean non-stainless steel.

Clean the outside of the dishwasher, especially the door handle, once a day. Clean stainless steel surfaces with cleaning agents suitable for stainless steel only.

## 11.5 Cleaning the surrounding area

- Do not use aggressive detergents (e.g. aggressive tile cleaners).
- Make sure that no water can enter the machine unintentionally.
- Do not flood the surrounding area.

## 11.6 Descaling



### **WARNING – Danger of injury from contact with acids**

- Observe the safety data sheets and dosing recommendations of the chemical manufacturers.
- Use safety eyewear.
- Wear protective gloves.
- Remove descaler residues from all parts of the machine without delay to avoid damage.

Operating the dishwasher using hard water causes lime scale deposits to occur on the boiler interior and tank interior. Descale the inside of the tank, if necessary.

The boiler can be descaled by a service technician only.

Operating the dishwasher using hard water can cause lime scale deposits to occur in the boiler interior and tank interior. If this occurs, it is necessary to descale the tank interior, the boiler casing, the tank heating, the boiler heating and the wash and rinse systems.

Notes on descaling:

- For descaling, only use products suitable for commercial dishwashers. Follow the manufacturer instructions.
- Completely flush the descaling agent out of the dishwasher. To do so, perform 3–6 wash cycles without a rack. Any remaining descaling agent residues must be removed using a soft cloth and hot water. Then, perform a final wash cycle.

- Drain the dishwasher at the end of the descaling process.
- Assign the task of descaling the boiler to the customer service, if necessary.

## 12 Maintenance



### **WARNING – Danger to life from electric shock**

- Work on the electrical system must only be conducted by qualified personnel who comply with the electrotechnical rules.
- Disconnect the machine from the power supply before removing any casing parts or working on the electrical system. To do this, turn the local main switch to **OFF** and ensure that it cannot be switched back on again.
- Attach all housing parts again before switching on the voltage again.



### **WARNING – Danger of injury when entering a danger zone**

- Only qualified personnel may work on the machine.
- Remove unauthorized persons from the danger zone.
- Block off the danger zone and mark it for third parties.
- Always wear cut-resistant protective gloves when removing casing parts or working inside the machine.



### **CAUTION – Danger of burns from hot wash water, hot washware and hot machine parts**

- Wear protective gloves, if necessary.
- Let the washware cool down before emptying, if necessary.
- Let the machine cool down before touching machine parts, if necessary.
- Never open the door during a wash cycle.
- Only open and close the door using the designated handle(s).



## **IMPORTANT**

### **Environmental damage due to improper disposal of liquids**

Environmentally hazardous liquids may be used during work on the machine. Improper disposal of these liquids can cause environmental damage.

- Always capture, store and transport liquids in suitable containers.
- Never mix liquids.
- Dispose of liquids properly in accordance with local requirements.

## **12.1 Maintenance work**



### **IMPORTANT**

Maintenance work must only be carried out by an authorized in-house technician or an authorized service technician.

MEIKO recommends having the machine serviced by an authorized service technician at least once a year and concluding a maintenance contract. As part of the maintenance, an electrical safety inspection is also carried out. Wear parts are checked and replaced, if necessary, and the machine is tested. Neglected or improper maintenance increases the residual risk of unforeseen damage to property and persons, for which no liability will be assumed.

Wear parts include, for example:

- Dosing hoses
- Door seal
- Supply water hose

## 12.2 Maintenance plan

Maintenance work	Checked	Cleaned	Replaced	Maintenance requirement (minimum)
<b>1. Pumps</b>				
Check pumps for leaks and any visible damage				Once a year
Check pumps for running noise and correct function				Once a year
Check pump sieves for correct seating/function				Once a year
Check slide ring sealing/counter ring				Once a year
<b>2. Wash systems</b>				
Check water level in tank				Once a year
Check wash water pipe for leaks				Once a year
Check that wash arm is complete and generates correct spray pattern				Once a year
Check rotating arm hub				Once a year
<b>3. Fresh water final rinse</b>				
Check flow water pressure				Once a year
Check that rinse system is complete and generates correct spray pattern				Once a year
Check system for leaks				Once a year
<b>4. Casing and built-in components</b>				
Check casing parts and tank for damage and correct operation				Once a year
Check tank cover sieves				Once a year
Check boiler, hoses, clamps, plastic parts and seals				Once a year
<b>5. Fresh water installation</b>				
Check level control				Once a year
Check valves, clean dirt trap				Once a year
Check the air gap for cleanliness and tightness of the connections (visual inspection)				Once a year
<b>For partial/full demineralization: check function</b>				Once a year
<b>With GiO-MODUL: Carry out pre-filter change</b>				Every 6 months
<b>6. Wastewater installation</b>				
Check for tightness				Once a year

<b>Maintenance work</b>				<b>Checked</b>	<b>Cleaned</b>	<b>Replaced</b>	<b>Maintenance requirement (minimum)</b>
For drain pumps, check pressure hose position and draining behavior							Once a year
<b>7. Electrical safety check (optional certificate)</b>							
Perform visual check							Once a year
Check protective conductor							Once a year
Measure insulation resistance							Once a year
Measure current on protective conductor							Once a year
<b>8. Detergent dosing</b>							
Check dosing and adjust, if necessary							Once a year
Replace peristaltic hose and associated seals on the nozzles							Once a year
Check detergent dosing system is working and not leaking							Once a year
<b>9. Rinse aid dosing</b>							
Check dosing and adjust, if necessary							Once a year
Replace peristaltic hose and associated seals on the nozzles							Once a year
Check rinse aid dosing system is working and not leaking							Once a year
<b>10. Test run with functional test of entire machine</b>							
Check test wash and rinse results							Once a year
Visually check entire machine for leaks							Once a year
<b>11. Water quality, temperature</b>							
Drinking water	°F	gpg	µS/cm				Once a year
Water quality after water treatment (if available)	°F	gpg	µS/cm				Once a year

## 13 Dismantling and disposal

In addition to valuable raw materials and recyclable materials, the packaging and the old machine may also contain substances that are harmful to health and the environment but were required for the function and safety of the old machine.

### 13.1 Dismantling and disposal of the old machine



#### **WARNING – Risk of injury from contact with chemicals**

- Observe the safety data sheets and dosing recommendations of the chemical manufacturers.
- Use safety eyewear.
- Wear protective gloves.
- Do not mix different chemical products.

If applicable, wash machine components, containers, dosing units and hoses with fresh water to remove chemical residues. Wear suitable clothing (gloves, safety glasses) for this.



The machine is marked with this symbol. Please observe the local regulations for proper disposal of your old machine.

The components should be separated based on the material and recycled.

# 14 Index

## A

Accessing the utility connections .37

AirConcept..... 19

## C

Change of products ..... 18

Cleaning .....67

    Descaling..... 71

    Surrounding area ..... 71

    weekly..... 69

Cleaning outer stainless steel  
surfaces .....70

Cleaning the surrounding area ....71

Code entry .....64

Commissioning .....45

    Requirements ..... 45

Connecting the detergent and rinse  
aid canisters .....44

Connecting the dosing system ....43

Connection

    Fresh water ..... 40

    Wastewater pipe ..... 41

## D

Daily cleaning .....68

Delivery contents ..... 5

Descaling.....71

Designation ..... 5

Detergent.....17

Detergent and rinse aid..... 17

Dismantling.....76

Dismantling and disposal .....76

Disposal of packaging materials..22

Disposal of the old machine ..... 76

Dosing units ..... 18

## E

Electrical installation..... 37

Electromagnetic compatibility ..... 12

Energy saving

    Waste air heat recovery.....19

## F

Functional description ..... 12

## G

Guarantee..... 7

## I

Illustration ..... 6

Install WAHR option ..... 25

Installation .....22, 25

Installing the Power Vent..... 30

Intended use ..... 7

## L

Level 1 ..... 64

Level 2 ..... 66

## M

Maintenance ..... 73

Maintenance plan..... 74

Malfunctions ..... 58

Membrane keypad ..... 14, 70

Messages ..... 59

Misuse ..... 7

Modifying the settings ..... 64

<b>N</b>		
Noise emission .....	20	
Notes on the operating instructions .....	5	
<b>O</b>		
Operation/use .....	47	
Options .....	19	
Overview illustration.....	13	
<b>P</b>		
Parameters		
View.....	65	
Performing commissioning .....	46	
Power Vent		
Description .....	19	
Preparation .....	47	
Pre-washing .....	53	
Priming the pipes .....	46	
Product description .....	12	
Program		
Assignment.....	16	
Programs		
FV 130.2 .....	16	
<b>R</b>		
Related documents .....	5	
Replacing the canisters.....	57	
Requirements for the electrical connection .....	24	
Requirements for the fresh water connection .....	23	
Requirements for the installation location .....	22	
Requirements for the personnel .	10	
Requirements for the wastewater connection .....	22	
Rinse aid .....	17	
<b>S</b>		
Safety .....	7	
Safety information .....	8	
Safety notices on the machine ...	10	
Safety symbols in the instructions	7	
Switching off .....	56	
Switching on .....	47	
<b>T</b>		
Technical data .....	20	
Terminating the installation .....	45	
Transport .....	20	
<b>U</b>		
Useful information for loading the washware .....	50	
<b>V</b>		
Venting (priming) the pipes .....	65	
Venting the pipes .....	46	
<b>W</b>		
Wash programs .....	16	
Washing		
Selecting the wash program.....	52	
Starting the wash cycle.....	53	
Starting up the dishwasher .....	49	
Unloading the washware .....	54	
Wastewater temperature control.	42	
What to do in the event of an emergency .....	9	





Scan QR code to access MEIKO U.S. ASA listings.  
ASA listing can also be accessed at  
[www.meiko.us](http://www.meiko.us)



**MEIKO Maschinenbau  
GmbH & Co. KG**  
Englerstraße 3  
77652 Offenburg  
Germany  
[www.meiko-global.com](http://www.meiko-global.com)  
[info@meiko-global.com](mailto:info@meiko-global.com)

**MEIKO USA, Inc.**  
1349 Heil Quaker Boulevard La  
Vergne, TN 37086  
Phone (615) 399-6600  
Toll Free (800) 55 MEIKO  
Fax (615) 399-6620  
[sales@meiko.us](mailto:sales@meiko.us)  
24H Toll Free Service +1 800 868  
3840  
[service@meiko.us](mailto:service@meiko.us)