

TopLine 20 / A  
links - rechts  
left - right  
gauche - droite  
izquierda - derecha  
manca - destra

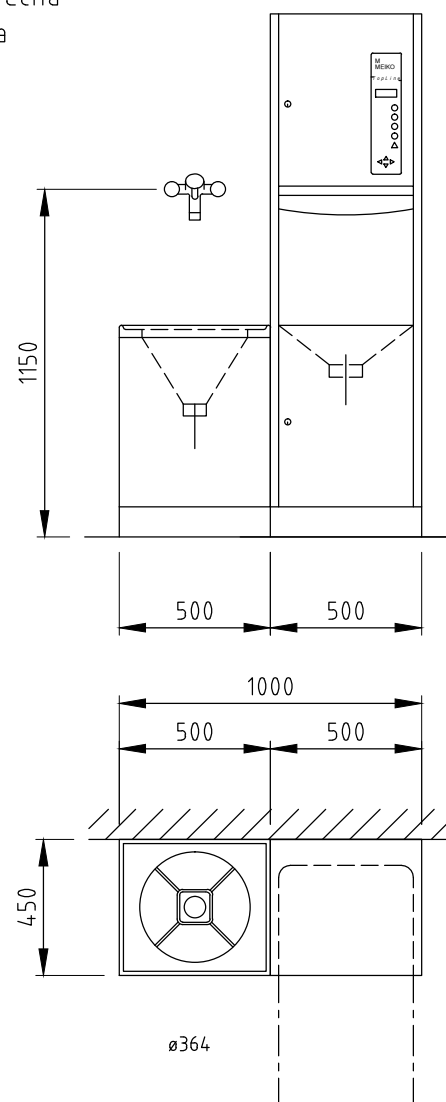

TopLine 20 / A  
rechts - links  
right - left  
droite - gauche  
derecha - izquierda  
destra - manca

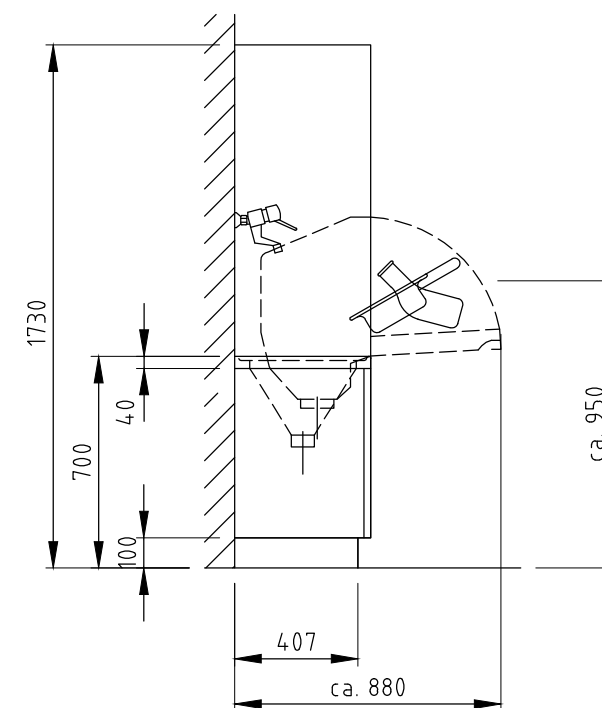
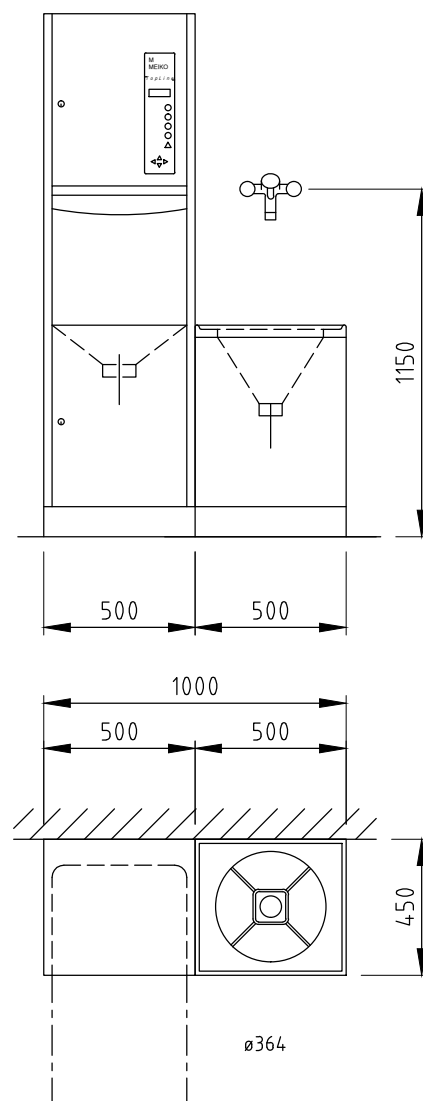

Bei Ihrer individuellen Planung unterstützen wir Sie gerne. Bitte nehmen Sie Kontakt mit uns auf.  
Für die Sanitär und Elektro - Anschlüsse fordern Sie bitte die aktuellen Montagezeichnung an.

We are pleased to support you with your individual planning proposals. Please do not hesitate to contact us.  
For further information on sanitary and electrical connections please request the current installation drawing(s).

Nous sommes volontiers à votre disposition pour vous assister dans vos planifications individuelles.  
Pour les connexions sanitaires et électroniques demandez nos plans d'installation actuels

Nos complace apoyarle con una propuesta de planificación para usted. No duda en ponerse en contacto con nosotros.  
Para las conexiones sanitarias y eléctricas, por favor solicite el plan actual de instalación.

Siamo lieti di aiutarVi nella fase di pianificazione. Vi preghiamo gentilmente di contattare il nostro ufficio.  
Siete invitati di ordinare i disegni di montaggio per allacciamenti idrici ed elettrici.



 <b>MASCHINENBAU GMBH &amp; CO.KG.</b> ENGLERSTR.3 77652 OFFENBURG GERMANY TEL. 0781/2030 E-MAIL: info@meiko.de		It is neither allowed to give this drawing without our permission to a third party for information or reproduction, nor may it be used for competition purposes. We reserve all rights !
Reference:		Type: TOPLINE20/A
Drawing-No.: P00-S08814 4	Project-No.: PN-TL-DE	Order-No.:
Scale: 1:25	drawn: 06.11.13 rm	checked: 14.11.13 rm
Customer checked:		